

YIJIAO 亿角

Expert in LED sign and capable of so much more

Create more value to brand with sign
用标识为品牌增加价值



www.yijiaocn.com

LED
LETTERS SIGN



SIGNAGE



LIGHT BOX

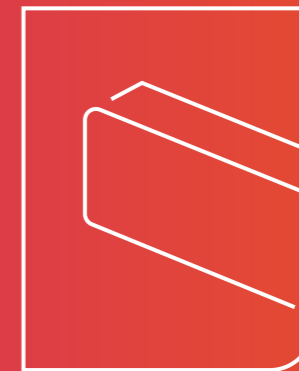

WINDOW
DISPLAY

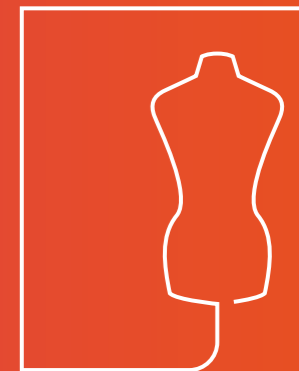

江苏省昆山千灯镇西纬路19号4#厂房

Factory Building 4, No.19, Xiwei Rd., Qiandeng Town, Kunshan, China.

Tel 0512-57055166 Fax 0512-57055167 E-mail sales@yijiaochina.com

"Expert in LED sign and capable of so much more"

YIJIAO 亿角



YIJIAO is established in 2008, now is a professional signage manufacturer in China. we are dedicated to providing the best level service along with quality illuminated and digital signage products and all kinds of light signs.

Since 2008, we continuously implement new technologies and ways of labour organization, even the most demanding customers.

Our rich experience on the sign industry ensures your signage project delivered on time and on budget.

YIJIAO is building a long lasting reputation on quality, reliability and cost effectiveness throughout.

We are working to make a living, but also to contribute to society with traditional values and joy of making sign, with a sense of achievement and happiness, we put our heart to every product.

亿角 创立于2008年, 至今已成为中国专业的标志制造商, 力求在小量生产中实现多品种和高质量产品的低成本生产。

从2008年至今, 我们从未间断对于新工艺及小细节的研究改进, 挑战最严苛的标准, 无限接近完美。

丰富的行业经验使得您的标志成品符合实用要求又符合美学要求, 专业的团队确保您的交期及质量要求。

亿角 长期致力于树立品质、服务、诚信的行业口碑。

我们不仅仅是为了生活而工作, 更是在寻找标志制作过程中的快乐, 在工作中找到成就感和幸福感, 我们用匠心做好每一个产品。

我们专业于标识, 也可以为您提供更多服务。



COMPANY HISTORY

公司历程

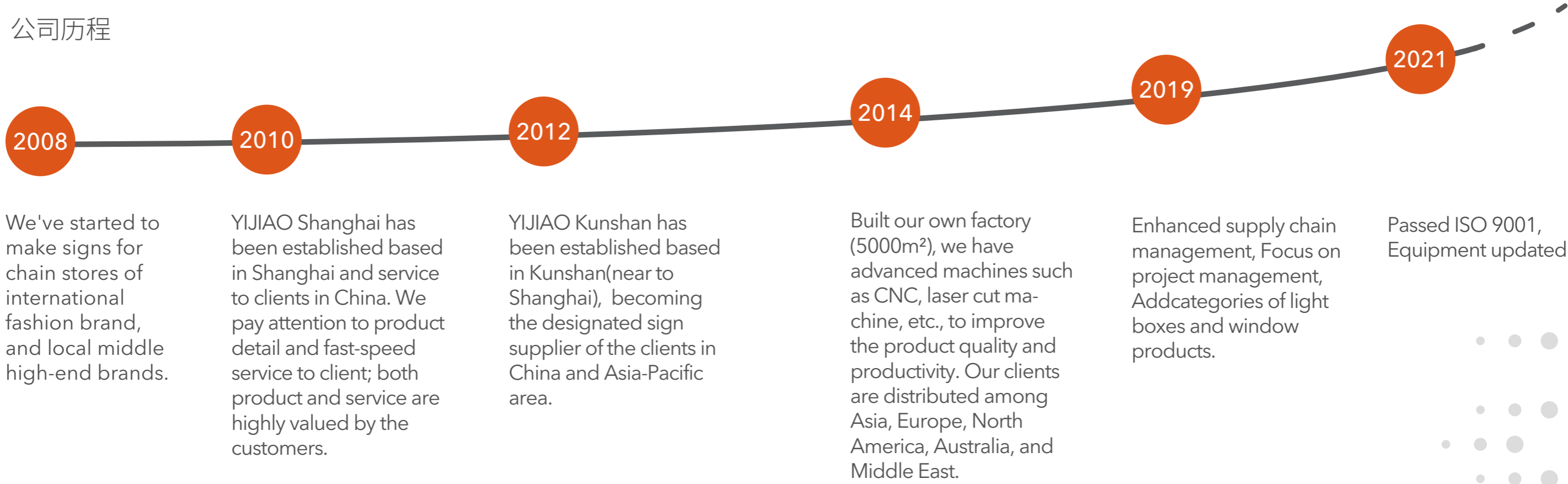

YIJIAO VISION

Focus on the challenges of customers in the retail industry, provide competitive sign solutions and services, and continue to create maximum value for customers.

聚焦零售行业客户关注的挑战，提供有竞争力的标识解决方案和服务，持续为客户创造最大价值。

YIJIAO Mission 企业使命

「 Create more value to retail brand with sign. 」
用标识为零售品牌增加价值

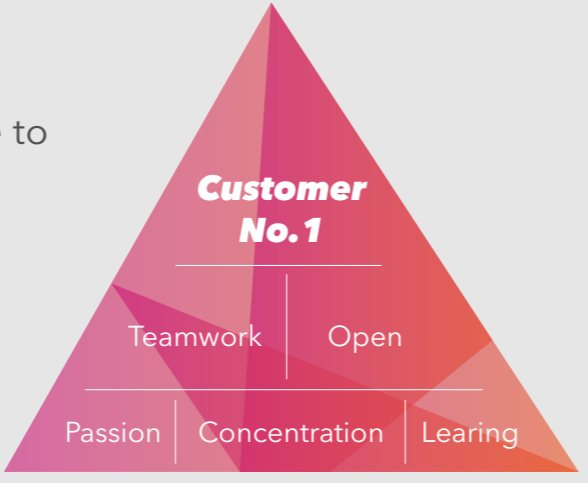

ADVANTAGES

<p>Professional Engineering Team</p> <p>专业的工程团队</p>	<p>Strict Quality Control</p> <p>严格的质量控制</p>	<p>Skilled Manufacturing</p> <p>精湛的制造工艺</p>
<p>18 Days Lead Time</p> <p>18天交货时间</p>	<p>Responsive Sales Team</p> <p>响应式销售团队</p>	<p>Reliable Logistics</p> <p>可靠的物流运输</p>

OUT-DOOR *sign*

大楼、高塔建筑招牌标志灯箱

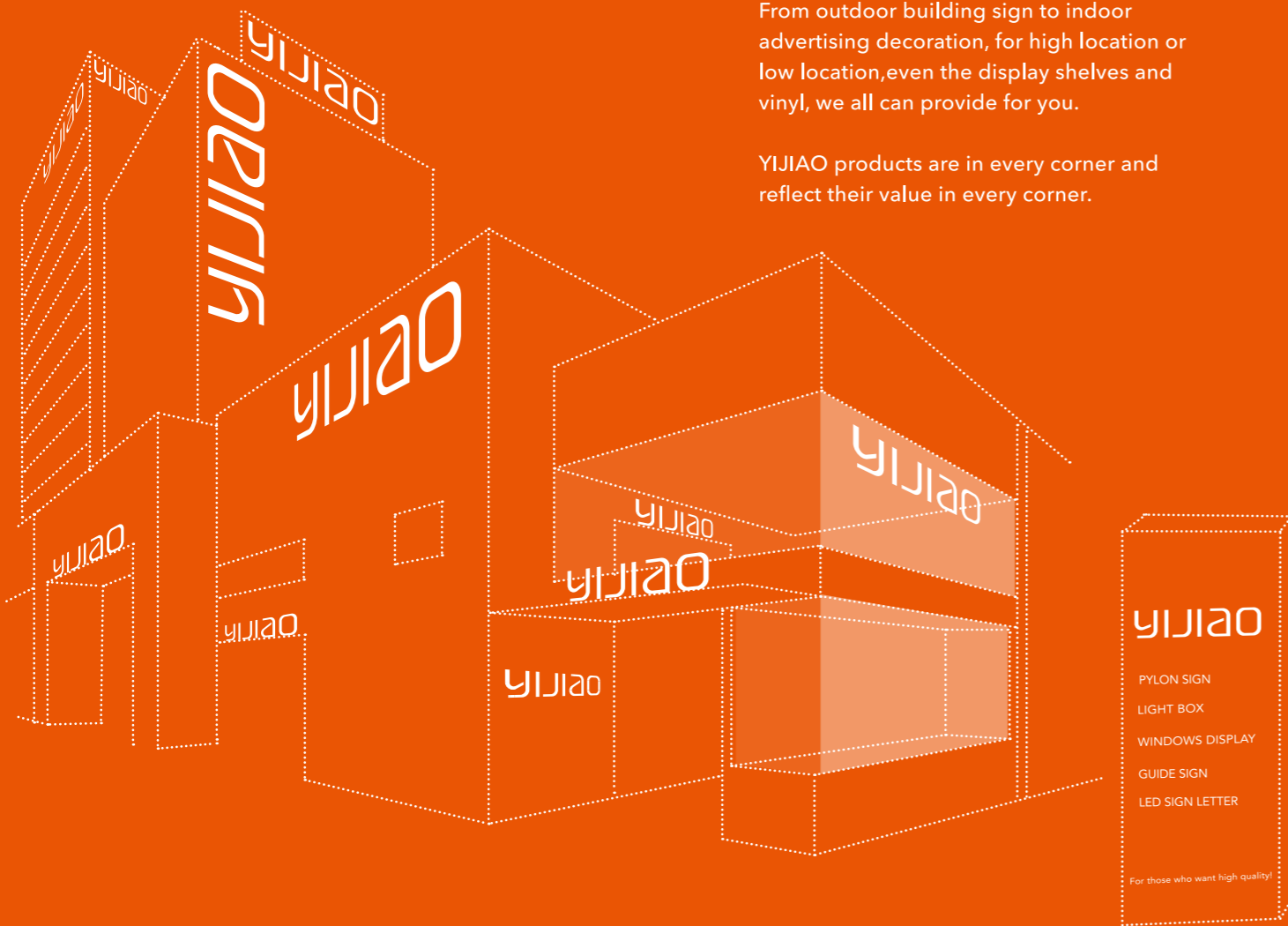

From outdoor building sign to indoor advertising decoration, for high location or low location, even the display shelves and vinyl, we all can provide for you.

YIJIAO products are in every corner and reflect their value in every corner.

DIS-PLAY *LOW LOCATION sign*

低楼层招牌标志灯箱

→ *WAY FINDING sign*

导向标识

WHAT WE DO

亿角标识 无限表示

从户外建筑标识到室内广告装饰，位于高处的或是低处的，甚至是展示道具和贴膜，我们都能为您解决。

亿角的产品存在于每个角落，并于这些细微处给客户带来价值。

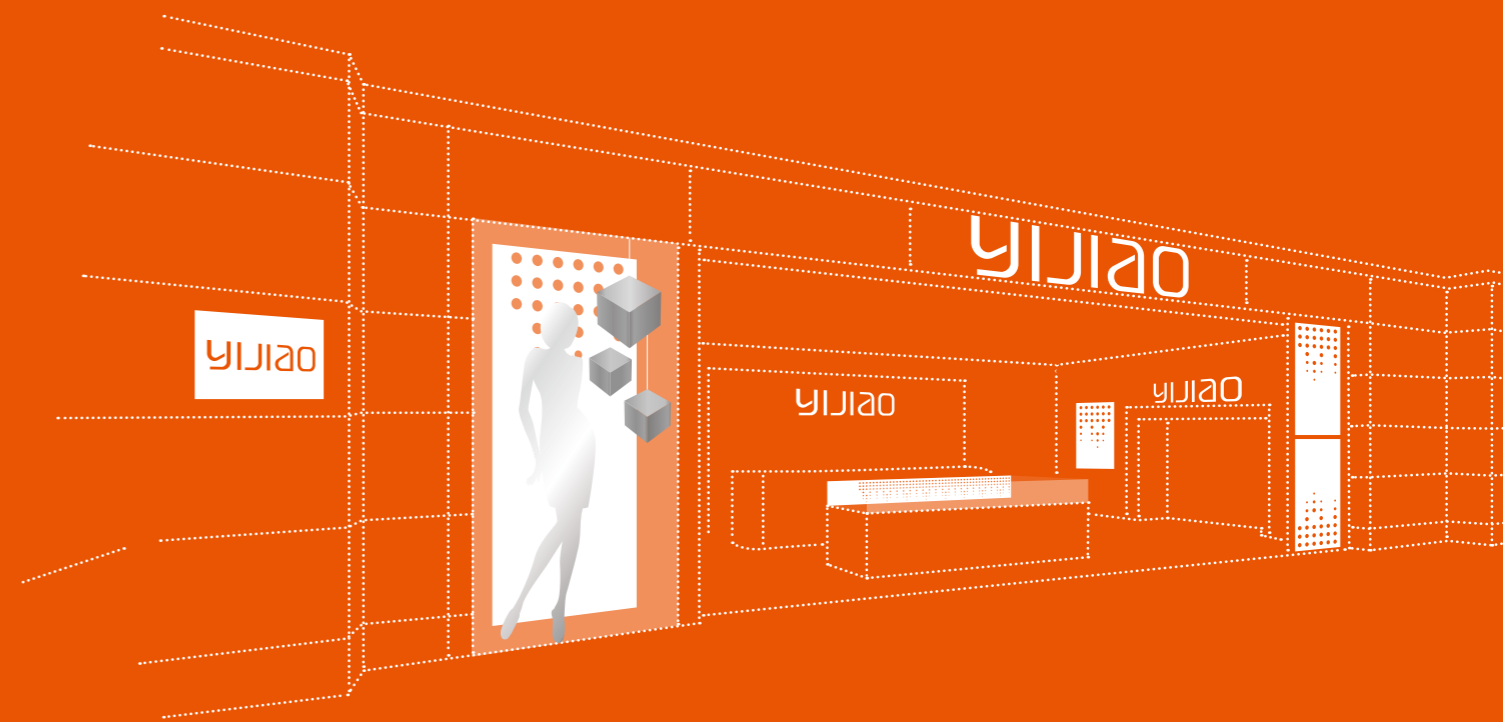



















CHAIN *CHAIN STORE sign*

连锁商店招牌标志灯箱

DECO *DECORATIVE applications*

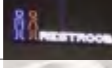
橱窗陈列

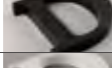
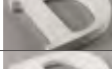
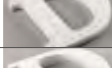
Product Index 产品目录

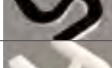
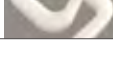
亚克力切割字/ 亚克力围边字 Acrylic Letter/ Acrylic Channel Letter	YJ-101		亚克力切割字 (薄)	Acrylic Letter (Thinner)	09
			亚克力切割字 (厚)	Acrylic Letter (Thicker)	09
	YJ-102		水晶字 2 层亚克力切割字	Acrylic Letter - 2 Layers of Acrylic	10
	YJ-103		亚克力切割字 + 贴膜	Acrylic Letter + Vinyl	10
	YJ-104		亚克力切割字 + 不锈钢	Acrylic Letter + Stainless Steel	10
	YJ-105		亚克力围边字	Acrylic Channel Letter	10
金属字 Metal Letter	YJ-201		金属围边字	Fabricated Metal Letter	11-12
	YJ-202		金属切割字	Flat Metal Cut Letter	11-12
发光字 Luminous Letter	YJ-M000A.B.C		压口字	Face Lit Channel Letter-With Trim	13-14
	YJ-M002		灯泡字	Bulb Replica	15
	YJ-M005A.B.C		金属背面发光字	Metal Back Lit Channel Letter	16
	YJ-M006		金属反口正面发光字	Face Lit Channel Letter-Without Trim	17
	YJ-M009		金属压口正面发光字	Metal Channel Letter-Front Lit With Trim Cap	17
	YJ-M014		树脂字	Resin Letter	18
	YJ-N001		斜边正面发光字	Face Lit Acrylic Letter-Bevel Edge	19
	YJ-N002		直边正面发光字	Acrylic Luminous Letter-Face Lit	19
			联体字	Letter United	20
	YJ-N003		透明圆角发光字	Acrylic Luminous Letter-Transparent Round Corner	21
	YJ-N004		透明直角发光字	Acrylic Luminous Letter-Transparent Square Corner	21
	YJ-N007		黑板正面发光字	Acrylic Luminous Letter-Black And White	22
	YJ-N008		直边正面背面发光字	Acrylic Luminous Letter-Face And Back Lit	22
	YJ-N010		灯珠正面发光字	Acrylic Luminous Letter-Skeleton By Opening LED	23
	YJ-N011		直边侧边发光字	Acrylic Luminous Letter-Partial Side Lit	23
	YJ-N013		直边侧边发光字	Acrylic Luminous Letter-Face And Half Side Lit	24
YJ-N015		亚克力侧面全发光字	Side Full Lit Letter	25	
YJ-N016		亚克力侧面正面发光字	Front And Side Full Lit Letter	25	

	YJ-N023		侧面正面发光字	Acrylic Luminous Letter Face And Partial Side Lit	27	
	YJ-M024		金属正面发光字	Metal Luminous Letter Front Lit	28	
霓虹灯字 Neon Letter	YJ-N017		霓虹灯字	Neon Letter	26	
	YJ-N012		灯条发光字	Acrylic Luminous Letter-Strip Lit	30	
	YJ-N018		霓虹灯字	Acrylic Neon Letter	31	
	YJ-N019		霓虹灯字	Acrylic Neon Letter	31	
	YJ-N020		霓虹灯字	Acrylic Neon Letter	32	
	YJ-N022		霓虹软灯条	Led Flexible Neon Sign	33-34	
			千层镜	Infinity Mirror Sign	35	
			导电玻璃	Conductive Glass	36	
	卡布灯箱 Fabric Light Box	YJ-F01		卡布灯箱	Fabric Light Box	38
		YJ-F02		卡布灯箱	Fabric Light Box	39
YJ-F03			卡布灯箱	Fabric Light Box	40	
YJ-F04			卡布灯箱	Fabric Light Box	41	
YJ-F05			卡布灯箱	Fabric Light Box	42	
YJ-F06			卡布灯箱	Fabric Light Box	43	
YJ-F07			卡布灯箱	Fabric Light Box	44	
定制灯箱 Customized Light Box		YJ-L01		圆形发光灯箱	Round Light Box	46
	YJ-L02		方形发光灯箱	Rectangle Light Box	47	
	YJ-L03		全发光灯箱	Full Illuminated Light Box	48	
标牌 Signage			盲文牌	Braille Signage	49-52	
			浮雕牌	Embossed Plaques	53-54	
太阳能 Solar Power			太阳能	Solar Power	59-60	

亚克力切割字

Acrylic Cut Letter



YJ-N101

亚克力切割字 (薄)
Flat Cut Acrylic Letter (thinner)



亚克力切割字 (厚)
Flat Cut Acrylic Letter (Thicker)

ACRYLIC COLORS



尺寸 Size	整体厚度:	2~30mm 可选
	The Overall Thickness	2-30mm Optional
颜色 Color	亚克力颜色:	Acrylic lab-dips
	Acrylic Color	
颜色 Color	表面处理:	贴膜 / UV 打印 / 金属切割字
	Surface Finish	Stick Vinyl / UV Printing / metal cut letter
	侧边处理:	烤漆 *
	Edge Finish	Painting*

1. 侧边颜色可选色系: Edge Painting Color Series Option

PANTONE® RAL NOS

2. 贴膜颜色可选色系: Vinyl Color Series Option



CHANNEL LETTER

Acrylic

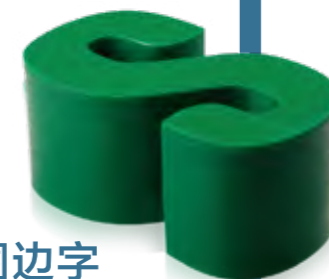

YJ-105

亚克力围边字
Acrylic Channel Letter

STICK VINYL

+ Acrylic

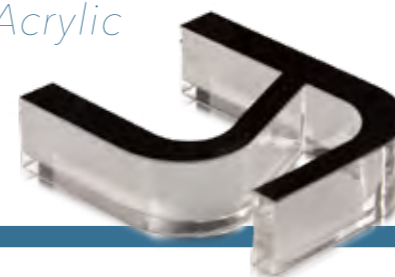

YJ-103

亚克力切割字 + 贴膜
Flat Cut Acrylic Letter + Vinyl

STAINLESS STEEL

+ Acrylic

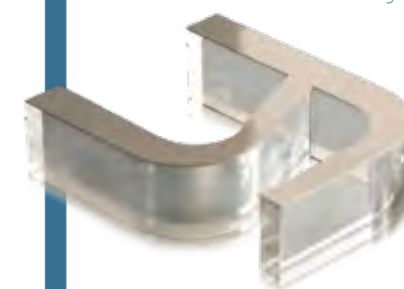

YJ-104

亚克力切割字 + 不锈钢
Flat Cut Acrylic Letter + Stainless Steel

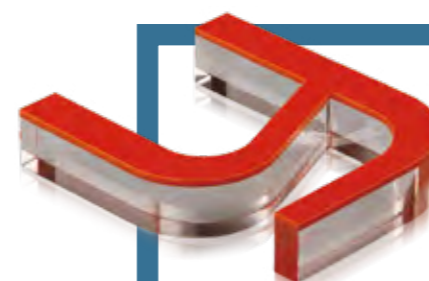

DOUBLE Acrylic

YJ-102

水晶字 2层亚克力切割字
Crystal Acrylic Letter-2 Layers of Acrylic

STAINLESS TEXTURES



金色镜面
GOLD Mirror / quality 304



金色拉丝
GOLD Brushed / quality 304



银色镜面
SILVER Mirror / quality 304



银色拉丝
SILVER Brushed / quality 304



铜色镜面
BRONZE Mirror / quality 304



铜色拉丝
BRONZE Brushed / quality 304

金属字

Metal Letter

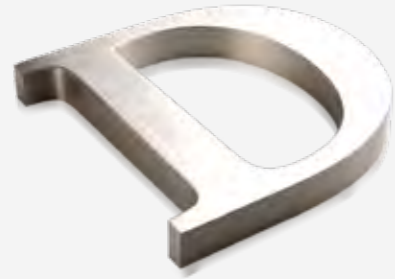

YJ-M201



YJ-M202

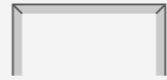

切面
Sections



尺寸 Size	整体厚度: The Overall Thickness	2~30mm 可选 2-30mm Optional
	最细笔画宽度: The Finest Stroke Width	8mm

造型 Surface Shapes	Prismatic Letter	Beveled Letter	Curved Letter
型號			
切面 Sections	Return 		
	No Return 		

Metal Color

COMBINATIONS	2B	N4	N8	HL	PO
SUS 304	X	X	X		
SUS 316			X	X	
TITANIUM GOLD(BRASS)			X	X	
TITANIUM ROSE GOLD (COPPER)			X	X	
TITANIUM BRONZE				X	
TITANIUM BLACK				X	
COPPER	X		X	X	X
BRASS	X			X	X
ZINCCORE	X				
STEEL	X				

BRASS is also available an aged look.

2B: Millfinish as it produced by the mill without surface treatment

N4: Satin finish with brushed 180 grid.

N8: Mirror machine polished surface.

HL: Satin finish with long hairline brush 360 grid.

PO: Mirror hand polished surface.

304: Stainless steel grade 304

316: Stainless steel grade 316, also called Marine Grade.

STAINLESS TEXTURES



金色镜面
GOLD Mirror / Quality 304

金色拉丝
GOLD Brushed / Quality 304

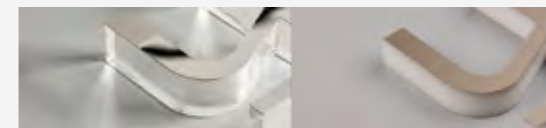

银色镜面
SILVER Mirror / Quality 304

银色拉丝
SILVER Brushed / Quality 304

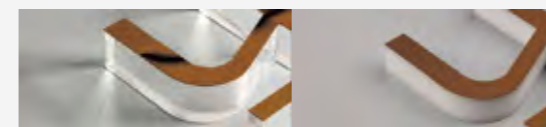

铜色镜面
BRONZE Mirror / Quality 304

铜色拉丝
BRONZE Brushed / Quality 304



多种类材需求接受订制
Various materials need to be customized.

发光字

Luminous Letter

发光形式

LIGHTING OPTIONS



正面发光 Front Light 正面与背面发光 Front & Back Light 侧面发光 Side Light



侧面一半发光 (前面) Front & Half Side Light 侧面与背面发光 (后面) Half Side Light (Back) 侧面一半和正面发光 Half Side Light (Front) 背面发光 Back Light



压口字

Led Channel Letter - Face lit With Trim Cap

YJ-M000A

类型 Type	正面发光 YJ-000 Front Light
光源 Light Source	SMD-LED 定制设计电路板 / LED 模组 Custom Made SMD-LED / LED Module
尺寸 Size	整体厚度: 50~120mm 可选 The Overall Thickness 50-120mm Optional 最细笔画宽度: 15mm The Finest Stroke Width 15mm



YJ-M000C

YJ-M000B

NOTE 1

灯箱字面板和底板方式 CHANNEL LETTER FACE AND BACK OPTIONS

F1 F2 F3 F4

BACK OPTIONS

B1 B2 B3 B4 B5 B6

Section

Pro LED acrylic Plane acrylic Polycarbonate (transparent) PVC Shoebox Soldered

发光字

Luminous Letter



灯泡字

Bulb Replica

YJ-M002

类型 Type	正面发光 YJ-M002 Front Light	
光源 Light Source	灯泡 Bulbs	
尺寸 Size	整体厚度: The Overall Thickness	50~180mm 可选 50-180mm Optional
	最细笔画宽度: The Finest Stroke Width	40mm 40mm

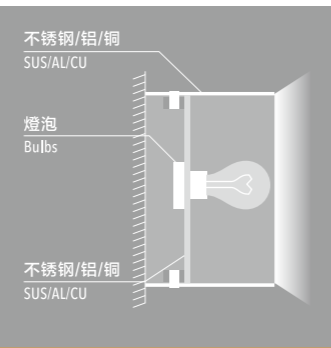

建议用于室内
For Indoor

金属背面发光字

Metal Back Lit Channel Letter

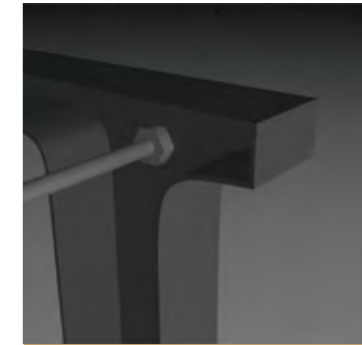
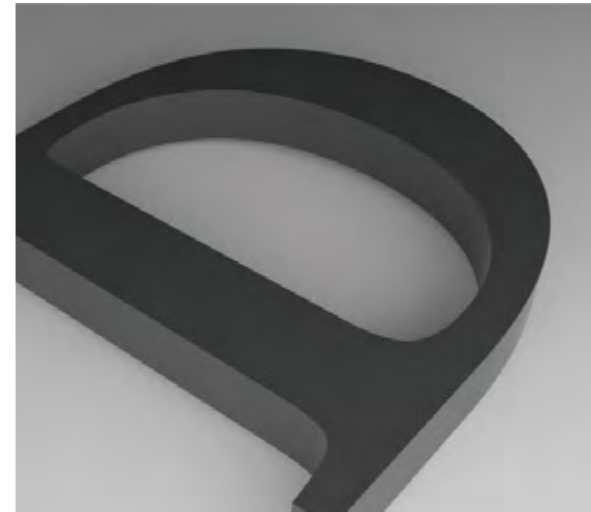

YJ-M005A

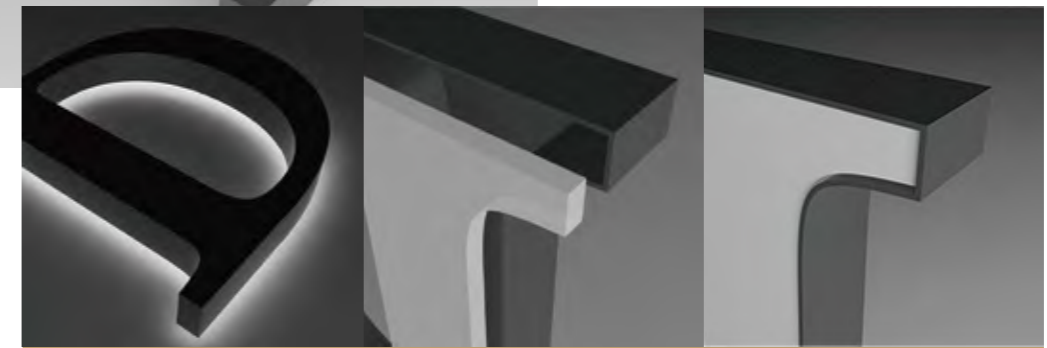

YJ-M005B



YJ-M005C

类型 Type	背面发光 YJ-005A.B.C Back Lit Metal Letter	
光源 Light Source	SMD-LED 定制设计电路板 / LED 模组 Custom Made SMD-LED / LED Module	
尺寸 Size	整体厚度: The Overall Thickness	20~80mm 可选 20-80mm Optional
	最细笔画宽度: The Finest Stroke Width	15mm 15mm

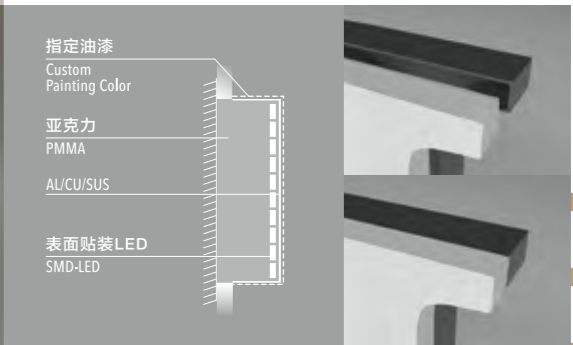

适用于室内外均可
Indoor + Outdoor

NOTE 2



白色透光材料，不同颜色 LED，灭灯时为原色，亮灯时的颜色都为灯光颜色

White light-passing material. Different led color. The sign presents the acrylic color when switched off, and luminous with led color when switched on.



LED 颜色
LED Light Color

不可直接接入 AC220V 电源
Don't Connect to 220V AC Power Directly



* 烤漆颜色可根据标准色系如 Pantone 订制。
Painting Color According to The Standard Color Code, exp. Pantone Code.



彩色透光材料，白色 LED，灭灯亮灯时均为彩色透光材料颜色

Colorful light-passing material, white LED, the sign presents the material's colors when switched on and off.



表面处理
Surface Finish

贴膜 / UV 打印
Stick Vinyl / UV Printing

侧边处理
Edge Finish

烤漆 *
Painting*

1. 侧边颜色可选色系 Edge Painting Color Series Option
PANTONE® RAL NCS

2. 贴膜颜色可选色系 Vinyl Color Series Option





金属反口正面发光字 YJ-M006

Metal Channel Letter -
Front Lit Without Trim Cap

类型 Type	正面发光 YJ-006 Front Light
光源 Light Source	SMD-LED 定制设计电路板 / LED 模组 Custom Made SMD-LED / LED Module
尺寸 Size	整体厚度: 40~100mm 可选 The Overall Thickness 40-100mm Optional
	最细笔画宽度: 15mm The Finest Stroke Width 15mm

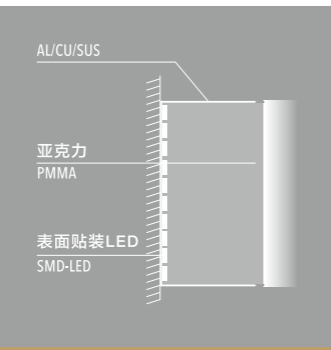

适用于室内外均可
Indoor + Outdoor



树脂字 YJ-M014

Resin letter

类型 Type	正面侧面发光 YJ-014 Front Lit Letter
光源 Light Source	SMD-LED 定制设计电路板 / LED 模组 Custom Made SMD-LED / LED Module
尺寸 Size	整体厚度: 25~60mm 可选 The Overall Thickness 25-60mm Optional
	最细笔画宽度: 8mm The Finest Stroke Width 8mm

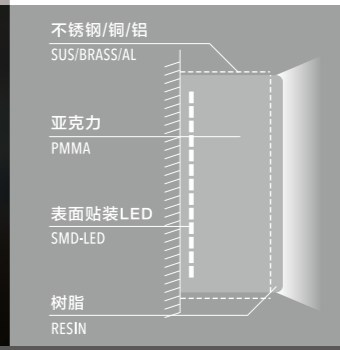
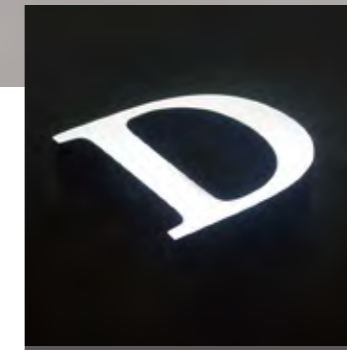

建议用于室内
For Indoor



金属压口正面发光字 YJ-M009

Metal Channel Letter -
Front Lit With Trim Cap

类型 Type	正面发光 YJ-009 Front Light
光源 Light Source	SMD-LED 定制设计电路板 / LED 模组 Custom Made SMD-LED / LED Module
尺寸 Size	整体厚度: 50~100mm 可选 The Overall Thickness 50-100mm Optional
	最细笔画宽度: 20mm The Finest Stroke Width 20mm

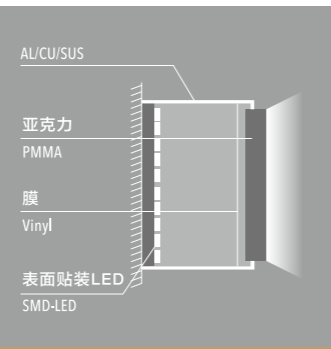

适用于室内外均可
Indoor + Outdoor

安装配件 INSTALL ACCESSORIES



NOTE 3

发光字

Luminous Letter



斜边正面发光字

YJ-N001

Acrylic Luminous Letter - Face Lit With Bevel Edge

类型 Type	正面发光 YJ-001 Front Light
光源 Light Source	SMD-LED 定制设计电路板 Custom Made SMD-LED
尺寸 Size	整体厚度: 20~30mm 可选 The Overall Thickness 20-30mm Optional
	最细笔画宽度: 8mm The Finest Stroke Width 8mm

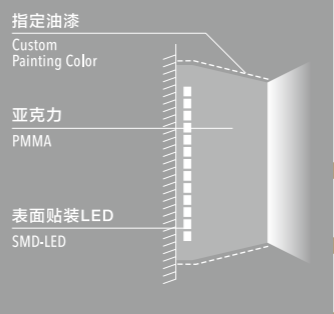

使用于室内外均可
Indoor + Outdoor



直边正面发光字

YJ-N002

Acrylic Luminous Letter -Face Lit

类型 Type	正面发光 YJ-002 Front Light
光源 Light Source	SMD-LED 定制设计电路板 Custom Made SMD-LED
尺寸 Size	整体厚度: 20~30mm 可选 The Overall Thickness 20-30mm Optional
	最细笔画宽度: 8mm The Finest Stroke Width 8mm

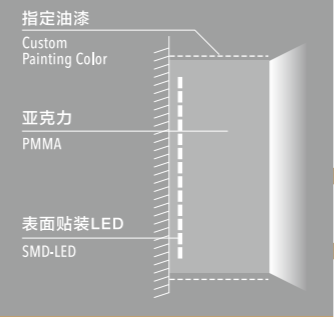

使用于室内外均可
Indoor + Outdoor



Letter United

Smaller & Thinner

The simple, highly visible design is suitable for both blade signs and hanging signs.

FOUR TYPES OPTIONS

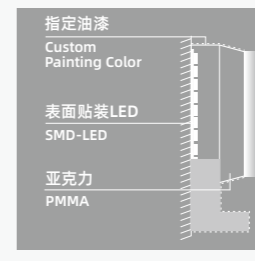
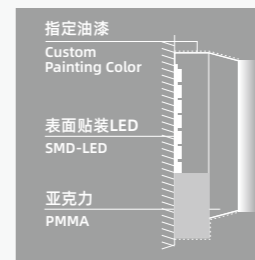
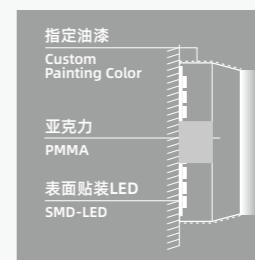
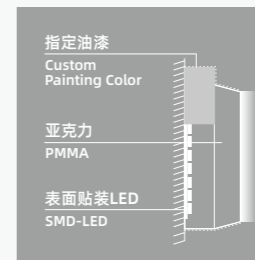

发光字

Luminous Letter



透明圆角发光字

YJ-N003

Acrylic Luminous Letter -
Transparent Round Corner

类型 Type	正面侧面发光 YJ-003 Front And Side Light
光源 Light Source	SMD-LED 定制设计电路板 Custom Made SMD-LED
尺寸 Size	整体厚度: 28~42mm 可选 The Overall Thickness 28-42mm Optional
	最细笔画宽度: 8mm The Finest Stroke Width 8mm

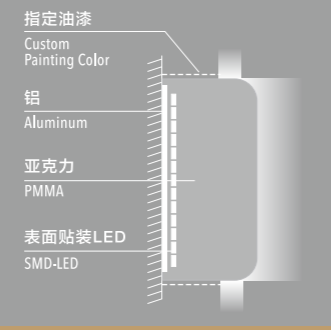

建议用于室内
For Indoor



黑白板正面发光字

YJ-N007

Acrylic Luminous Letter -
Black And White

类型 Type	正面发光 YJ-007 Front Light
光源 Light Source	SMD-LED 定制设计电路板 Custom Made SMD-LED
尺寸 Size	整体厚度: 25~35mm 可选 The Overall Thickness 25-35mm Optional
	最细笔画宽度: 8mm The Finest Stroke Width 8mm

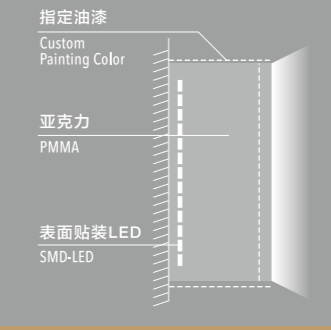

使用于室内外均可
Indoor + Outdoor



透明直角发光字

YJ-N004

Acrylic Luminous Letter -
Transparent Square Corner

类型 Type	正面侧面发光 YJ-004 Front And Side Light
光源 Light Source	SMD-LED 定制设计电路板 Custom Made SMD-LED
尺寸 Size	整体厚度: 30~45mm 可选 The Overall Thickness 30-45mm Optional
	最细笔画宽度: 8mm The Finest Stroke Width 8mm

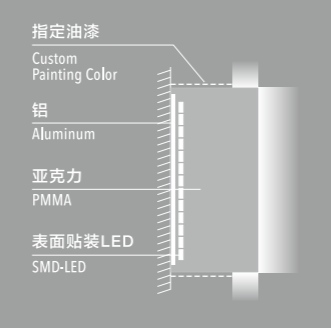

建议用于室内
For Indoor



直边正面背面发光字

YJ-N008

Acrylic Luminous Letter -
Face And Back Lit

类型 Type	正面背面发光 YJ-008 Front And Back Light
光源 Light Source	SMD-LED 定制设计电路板 Custom Made SMD-LED
尺寸 Size	整体厚度: 20~30mm 可选 The Overall Thickness 20-30mm Optional
	最细笔画宽度: 8mm The Finest Stroke Width 8mm

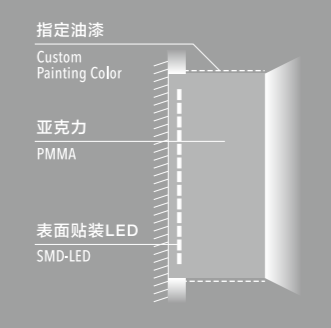

使用于室内外均可
Indoor + Outdoor

发光字

Luminous Letter



灯珠正面发光字

YJ-N010

Acrylic Luminous Letter -
Skeleton By Opening LED

类型 Type	正面发光 YJ-010 Front Light
光源 Light Source	SMD-LED 定制设计电路板 / LED 模组 Custom Made SMD-LED / LED Module
尺寸 Size	整体厚度: 20~30mm 可选 The Overall Thickness 20-30mm Optional 最细笔画宽度: 8mm The Finest Stroke Width 8mm

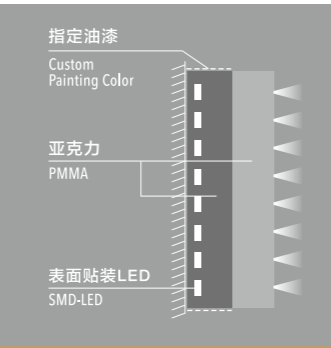

使用于室内外均可
Indoor + Outdoor



直边侧边发光字

YJ-N013

Acrylic Luminous Letter -
Face And Partial Side Lit

类型 Type	正面和侧面发光 YJ-013 Face And Partial Side Light
光源 Light Source	SMD-LED 定制设计电路板 Custom Made SMD-LED
尺寸 Size	整体厚度: 20~30mm 可选 The Overall Thickness 20-30mm Optional 最细笔画宽度: 8mm The Finest Stroke Width 8mm

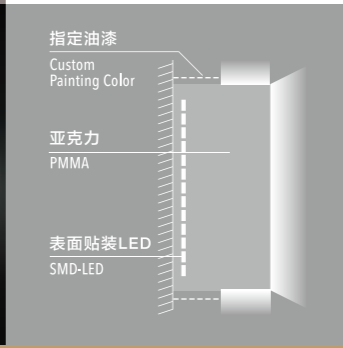

侧边可做喷砂处理
Abrasive Blasting



使用于室内外均可
Indoor + Outdoor



直边侧边发光字

YJ-N011

Acrylic Luminous Letter -
Partial Side Lit

类型 Type	侧面发光 YJ-011 Side Light
光源 Light Source	SMD-LED 定制设计电路板 / LED 模组 Custom Made SMD-LED / LED Module
尺寸 Size	整体厚度: 20~30mm 可选 The Overall Thickness 20-30mm Optional 最细笔画宽度: 8mm The Finest Stroke Width 8mm

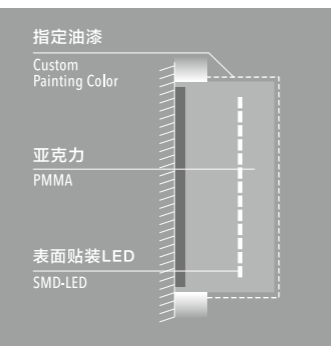

使用于室内外均可
Indoor + Outdoor

排灯方式

FACE LIT

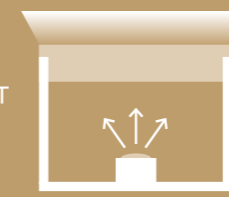

LM1

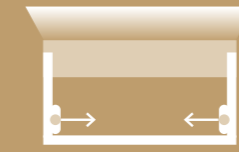

LM2



LM3

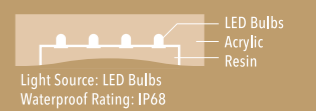

LM4

BACK LIT

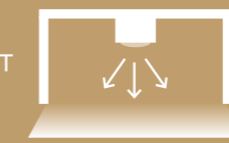

LM5



LM6



LM7

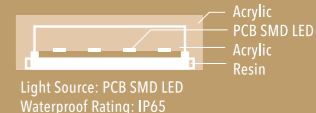

LM8

Examples of LED enlightening.
Face and back options can differ from shown examples.
Given sizes are indications.

NOTE 4

发光字

Luminous Letter



亚克力侧面全发光字

YJ-N015

Side Full Lit Letter

类型 Type	侧面发光 YJ-015 Side Full Lit Letter
光源 Light Source	SMD-LED 定制设计电路板 / LED 模组 Custom Made SMD-LED / LED Module
尺寸 Size	整体厚度: 25~30mm 可选 The Overall Thickness 25-30mm Optional
	最细笔画宽度: 25mm The Finest Stroke Width 25mm

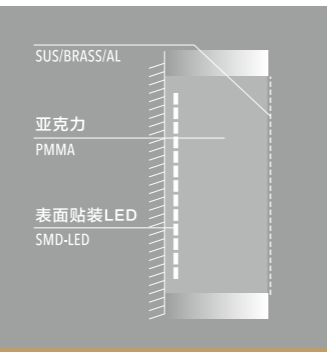

侧边可做喷砂处理
Abrasive Blasting



使用于室内外均可
Indoor + Outdoor



霓虹灯字

YJ-N017

Neon Letter

类型 Type	霓虹灯字 YJ-N017 Neon Letter
光源 Light Source	霓虹灯管 Glass Neon
尺寸 Size	灯管直径: 6, 7, 8, 9, 10, 12, 15, 18, 20mm 可选 Customizable 6, 7, 8, 9, 10, 12, 15, 18, 20mm Optional
	颜色 Color



使用于室内外均可
Indoor + Outdoor



亚克力侧面正面发光字

YJ-N016

Front And Side Full Lit Letter

类型 Type	亚克力侧面正面发光字 YJ-016 Front And Side Full Lit Letter
光源 Light Source	SMD-LED 定制设计电路板 / LED 模组 Custom Made SMD-LED / LED Module
尺寸 Size	整体厚度: 25~30mm 可选 The Overall Thickness 25-30mm Optional
	最细笔画宽度: 25mm The Finest Stroke Width 25mm



侧边可做喷砂处理
Abrasive Blas



使用于室内外均可
Indoor + Outdoor

JUNCTION BOX-1

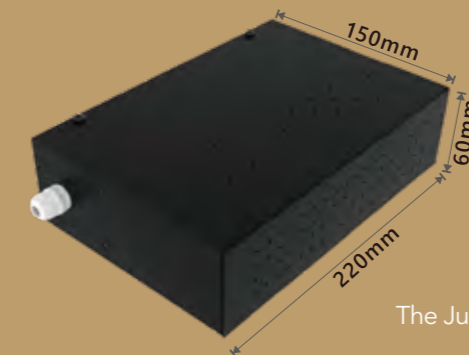

12V 35 Watt
12V 60 Watt
12V 100 Watt
12V 120 Watt

The Junction Box is for use with the Constant Voltage Drivers above.

SPECIFICATIONS

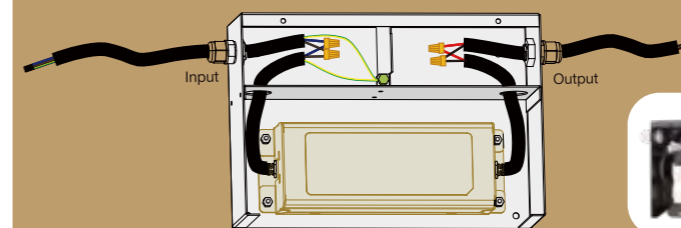

Enclosure: Steel
Environment: Indoor
Mounting: Integral mounting holes
Dimensions: 220*150*60mm(LxWxH)

Accessories: Cable gland, screws to secure drivers, screws to lock box in place

NOTE 5

发光字

Luminous Letter



侧面正面发光字

Acrylic Luminous Letter
Face And Partial Side Lit

YJ-N023

类型 Type	正面和侧面发光 Face And Partial Side Light	YJ-N023
光源 Light Source	草帽灯、RGB灯条 Embedded LED / RGB	
尺寸 Size	整体厚度: 31~36mm Customizable 31~36 mm Optional 最细笔画宽度: 25mm The Finest Stroke Width 25 mm	

侧面可做喷砂处理
Abrasive Blasting

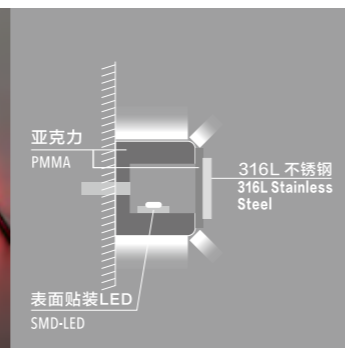

使用于室内外均可
Indoor + Outdoor

金属正面发光字

Metal Luminous Letter
Front Lit

YJ-M024



类型 Type	正面发光 Front Light	YJ-M024
光源	SMD-LED 定制设计电路板/LED 模组 Custom Made SMD-LED/LED Model	
尺寸 Size	整体厚度: 25~60mm Customizable 25~60 mm 最细笔画宽度: 15mm The Finest Stroke Width 15 mm	

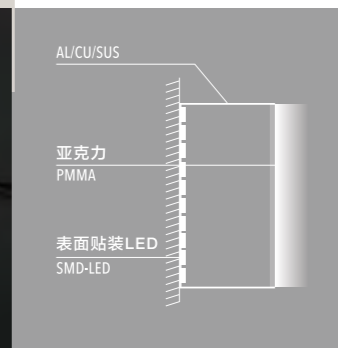
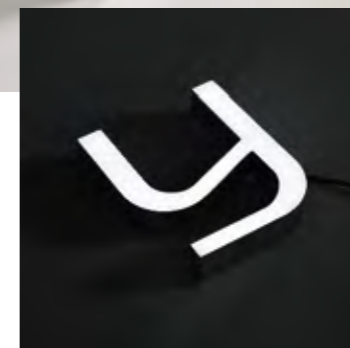

使用于室内外均可
Indoor + Outdoor

Marine grade 316L stainless steel	Waterproof grade IP 68
Customized led lighting	UV stable acrylic
	
	
	

包装方式 PACKAGING

P1			P4		
P2			P5		
P3					

NOTE 6

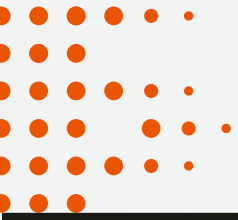

ACRYLIC NEON SERIES

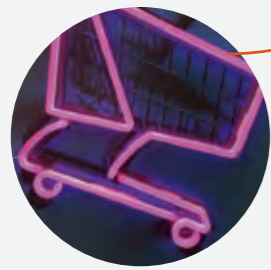

a FULL ACRYLIC
Perfect for fitting & shipping

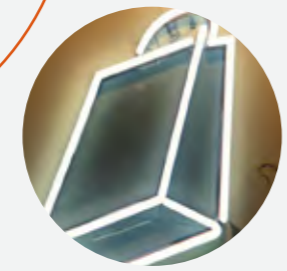

b LOW VOLTAGE
We only supply 12v & 24v options

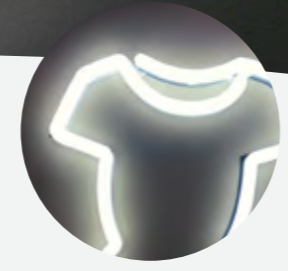

c BRAND ACCURACY
Recreate letters & shapes with greater accuracy than ever possible with traditional neon.

ACRYLIC COLOR OPTION

Colors shown are in stock, custom colors are available to order in larger quantities.



灯条发光字

YJ-N012

Acrylic Luminous Letter - Strip Lit

类型 Type	正面发光 YJ-012 Front Light
光源 Light Source	SMD-LED 定制设计电路板 Custom Made SMD-LED
尺寸 Size	整体厚度: 20~30mm 可选 The Overall Thickness 20-30mm Optional
	最细笔画宽度: 8mm The Finest Stroke Width 8mm

使用于室内外均可
Indoor + Outdoor

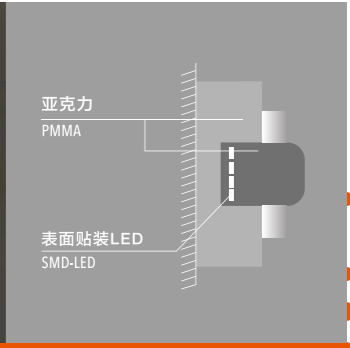

SHOWCASE OF OUR LATEST WORK

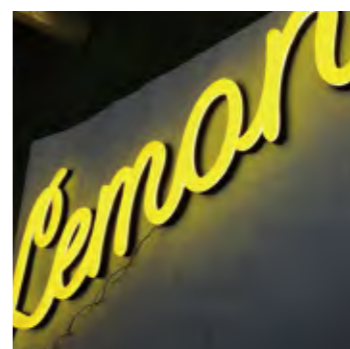
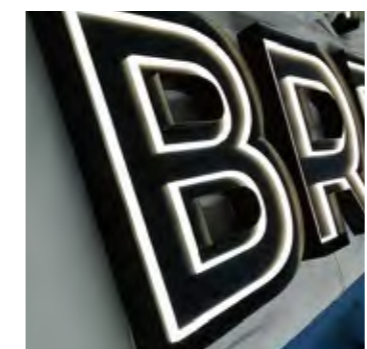

霓虹灯字

Neon Letter



霓虹灯字

YJ-N018

Neon Letter

类型 Type	霓虹灯字-可定制颜色亚克力 Neon Letter	YJ-N018
光源 Light Source	可定制灯条 LED Strip	
尺寸 Size	整体厚度: 25, 27, 30mm 可选 Customizable 25, 27, 30mm Optional	
	笔画宽度: 12, 15, 18mm 可选 Customizable 12, 15, 18mm Optional	
颜色 Color	可定制 Customizable	表面处理 哑光/亮光 Color Customizable

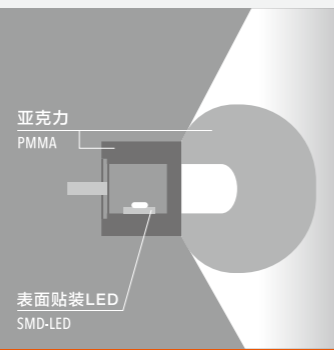

使用于室内外均可
Indoor + Outdoor

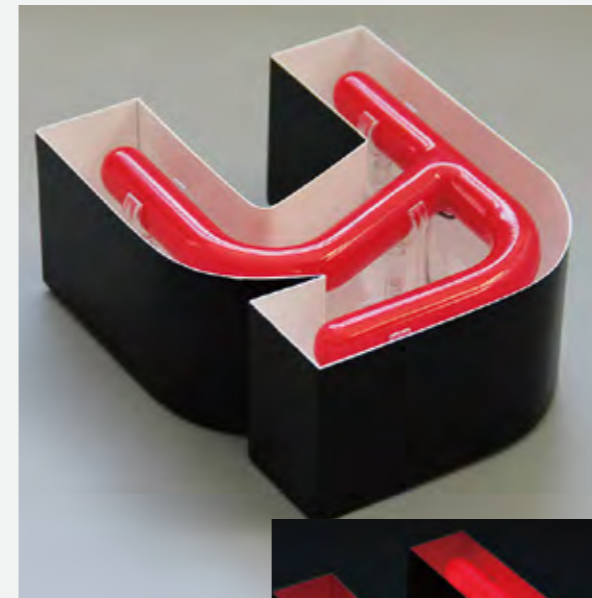

霓虹灯字

YJ-N020

Neon Letter

类型 Type	霓虹灯字-可定制颜色亚克力 Neon Letter	YJ-N020
光源 Light Source	可定制灯条 LED Strip	
尺寸 Size	整体厚度: 18, 22, 25mm 可选 Customizable 25, 27, 30mm Optional	
	笔画宽度: 18, 22, 25mm 可选 Customizable 18, 22, 25mm Optional	
颜色 Color	可定制 Customizable	表面处理 哑光/亮光 Color Customizable

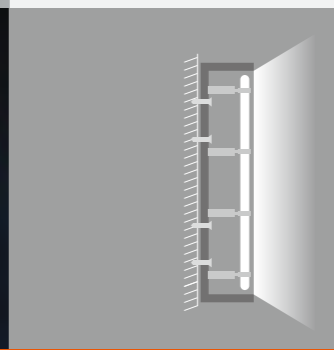

建议使用于室内橱窗
For Indoor, Window Display

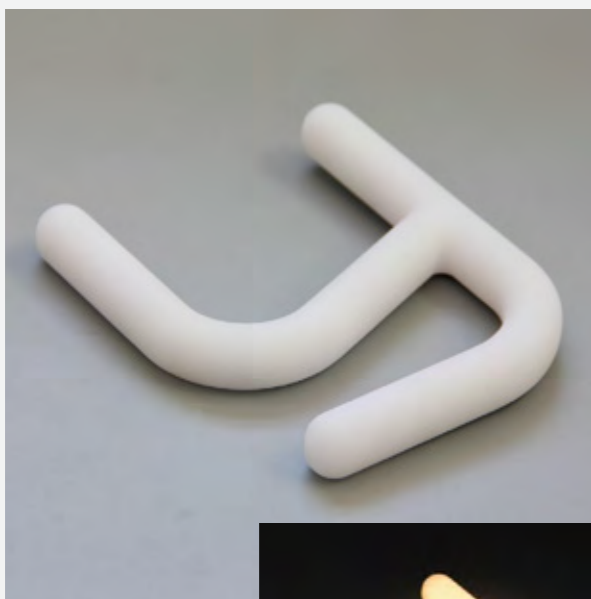

霓虹灯字

YJ-N019

Neon Letter

类型 Type	霓虹灯字-可定制颜色亚克力 Neon Letter	YJ-N019
光源 Light Source	可定制灯条 LED Strip	
尺寸 Size	整体厚度: 18, 22, 25mm 可选 Customizable 18, 22, 25mm Optional	
	笔画宽度: 18, 22, 25mm 可选 Customizable 18, 22, 25mm Optional	
颜色 Color	可定制 Customizable	表面处理 哑光/亮光 Color Customizable

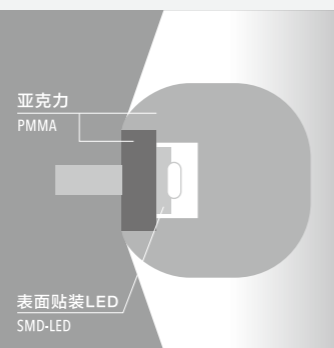

建议使用于室内橱窗
For Indoor, Window Display

About Artwork Conversation

*Please note your original logo art work will be converted into a special artwork for production.

Original Logo Artwork

Yijiao

There are a variety of features such variable width strokes or calligraphic design.

Creating Paths

Yijiao

Not just tracing the center lines but we keep the original logo features when creating the special artwork.

Decide the stroke Width

Yijiao

We will propose the suitable stroke width based on the signage size and generate the special artwork for production. Once you approve it, we will start the production.

Features of Converted Logo Artwork

Logo's stroke width becomes even

a → *a*

Round inner corner becomes sharp

f → *f*

End of line becomes round

a → *a*

NOTE 7

LED FLEXIBLE NEON SIGN

Turn your idea into a gorgeous custom-made modern LED Neon

NINE NEON LIGHT COLORS

Colours shown on the right are in stock, custom colours are available to order in larger quantities.

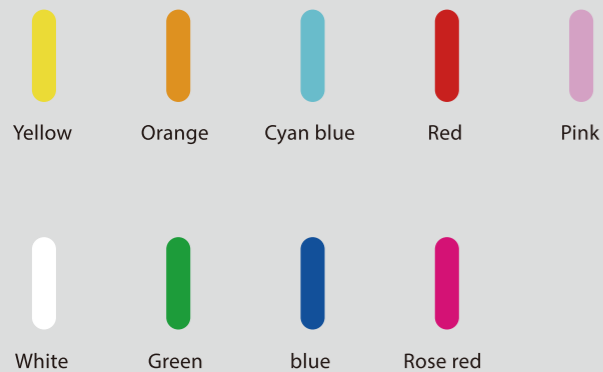

FIVE THICKNESS OPTIONS

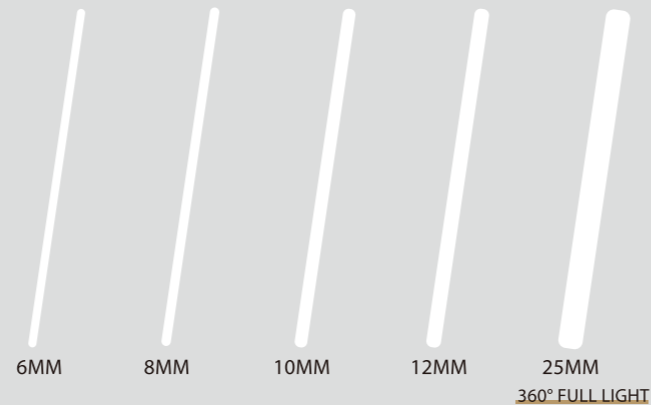

DIFFERENT BACKING OPTIONS

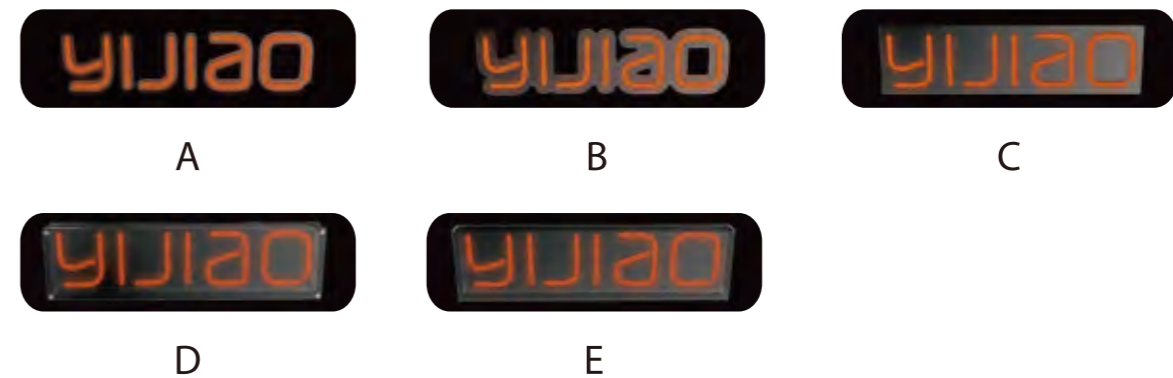

PLUG TYPE

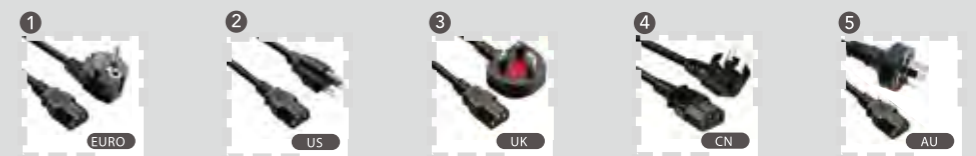

DIMMERS & RGB CONTROLLERS



INSTRUCTION DIAGRAM



SHOW CASE OF OUR LATEST WORK



千层镜 Infinity Mirror Sign



类型 Type	正面发光 Front Light
光源 Light	LED、RGB灯条 LED Strips / RGB
尺寸 Size	整体厚度: 30~200mm Customizable 30~200 mm Optional

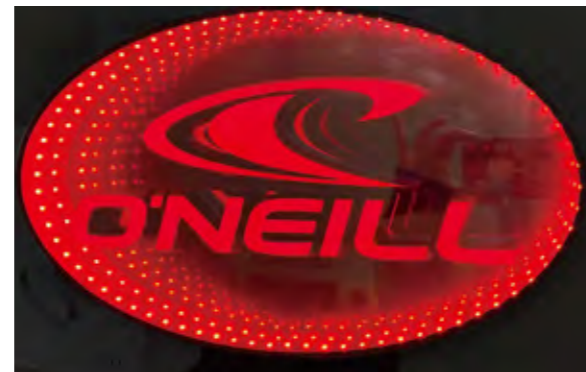
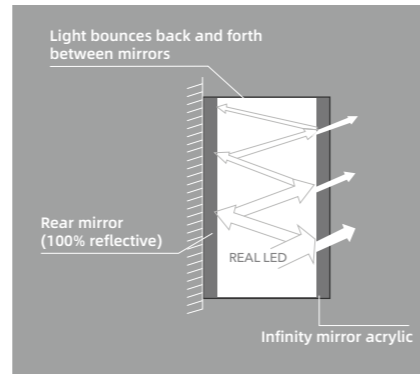
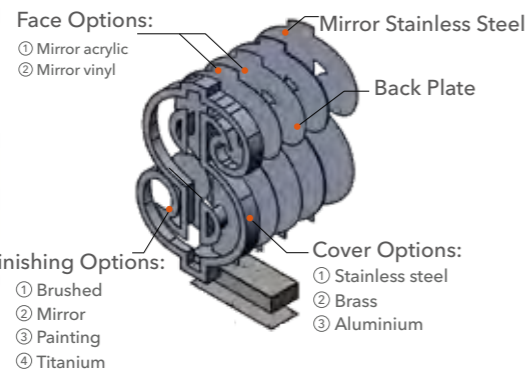

导电玻璃 Conductive Glass

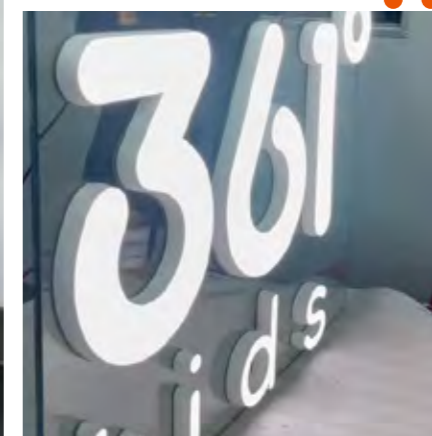
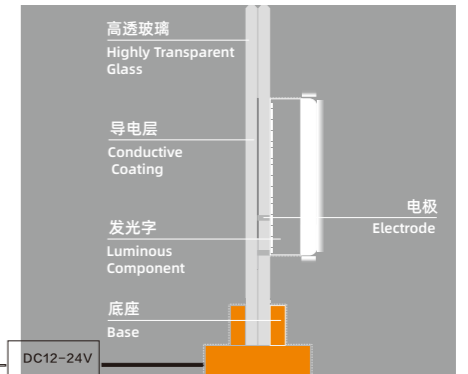

Fabric light box

铝框灯箱
ALUMINOUS LIGHT BOX
创造视觉 呈现完美
PERFECT VISION

The light box can be disassembled and assembled by itself. It is simpler and more convenient to install than traditional boxes, and it also reduces transportation costs.
这款灯箱比传统的灯箱安装简单方便，同时也降低了运输成本。

特点

- 1.安装简便，适合嵌入式、吊装等多种安装方式。
- 2.安全节能，低压LED光源。
- 3.发热温度低，90%的电能转化为光能。
- 4.视力保护，无频闪，长时间使用不会使眼睛疲劳，具有高显色性。
- 5.新型时尚：灯光自然柔和，温馨华丽，适用于任何时尚地域。

Features

- 1.Easy installation, suitable for multiple installation methods such as embedded and hanging.
- 2.Safe and energy saving, low voltage LED light source.
- 3.Low heating temperature, 90% of electric energy is converted into light energy.
- 4.Eye protection, no stroboscopic, long-term use will not cause eye fatigue, and has high color rendering.
- 5.New fashion: natural and soft lighting, warm and gorgeous, suitable for any fashion area.



 建议使用于室内
For Indoor

 电压 12V/24V
DC 12V/24V



卡布灯箱

YJ-F01

Fabric Light Box

颜色 Color	阳极氧化铝/定制 Oxidates Alloy Aluminum/Customized		
可视面 Visible Surface	单面 Single		
输入电压 Input Voltage	12V/24V 12V/24V		
包装 Package	气泡袋&纸箱&木箱 Bubble Bag&Cartons&Wooden Case		
尺寸 Size	定制 Customized	厚度 Thickness	40mm 40mm

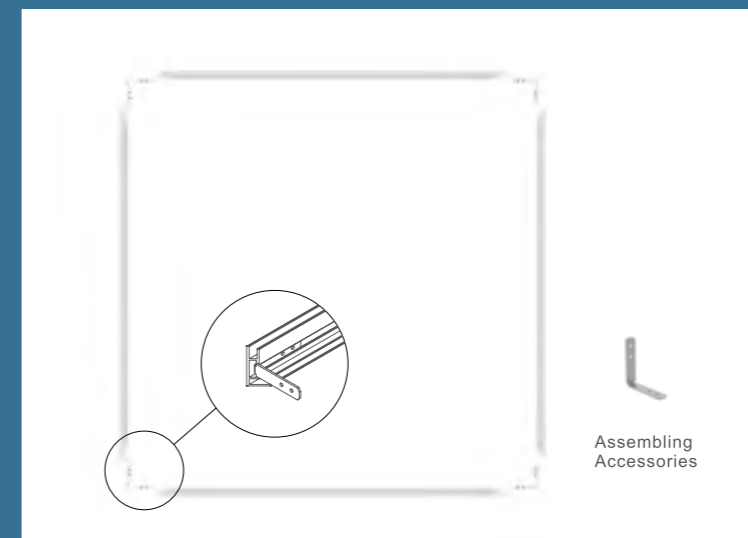

* 烤漆颜色外框的基本颜色的铝原色，如需定制其他颜色，请和我们联系。
Basic color of the frame is Alumite Silver, and customized painted color is also available. Please contact us for further information.

* 定制尺寸的正常时间是2-3周，时间可能会根据情况稍有调整，请在下单时和我们的销售联系具体交期。
Customized sizes have a standard lead time of 2-3 weeks. However, it may vary depending on the situation. Please contact our Sales Representative for urgent matters.

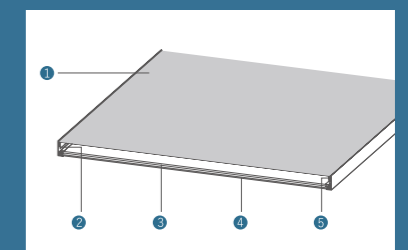

- | | |
|-------------------------------|--------------------------------|
| 1. UV 打印灯布
UV Print Fabric | 4. 背板
Back Panel |
| 2. 框架
Frame Profile | 5. 硅胶条
Silicon Rubber Strip |
| 3. LED 灯
LED Light Strip | |

NOTE 8



卡布灯箱

YJ-F02

Fabric Light Box

颜色 Color	阳极氧化铝/定制 Oxidates Alloy Aluminum/Customized		
可视面 Visible Surface	单面 Single		
输入电压 Input Voltage	12V/24V 12V/24V		
包装 Package	气泡袋&卡通纸箱&木箱 Bubble Bag&Cartons&Wooden Case		
尺寸 Size	定制 Customized	厚度 Thickness	60mm 60mm

建议用于室内
For Indoor

电压 12V/24V
DC 12V/24V



卡布灯箱

YJ-F03

Fabric Light Box

颜色 Color	阳极氧化铝/定制 Oxidates Alloy Aluminum/Customized		
可视面 Visible Surface	单面 Single		
输入电压 Input Voltage	12V/24V 12V/24V		
包装 Package	气泡袋&纸箱&木箱 Bubble Bag&Cartons&Wooden Case		
尺寸 Size	定制 Customized	厚度 Thickness	80mm 80mm

建议用于室内
For Indoor

电压 12V/24V
DC 12V/24V

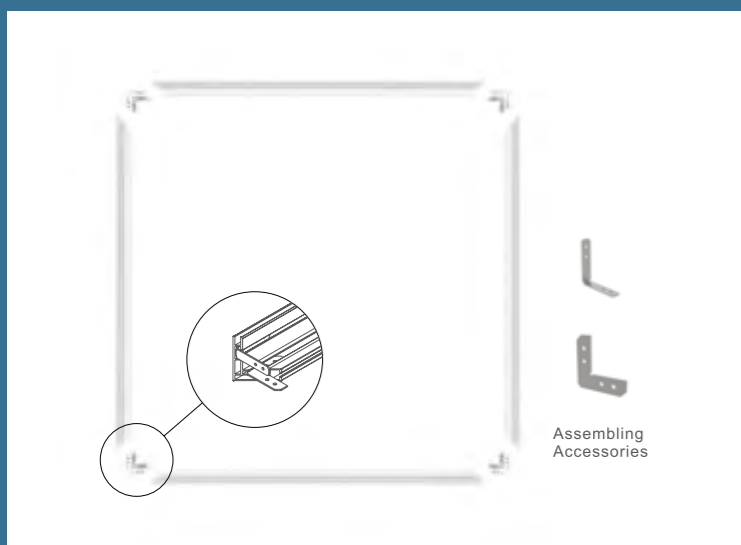

Assembling Accessories

* 烤漆颜色外框的基本颜色的铝原色，如需定制其他颜色，请和我们联系。
Basic color of the frame is Alumite Silver, and customized painted color is also available. Please contact us for further information.

* 定制尺寸的正常时间是2-3周，时间可能会根据情况稍有调整，请在下单时和我们的销售联系具体交期。
Customized sizes have a standard lead time of 2-3 weeks. However, it may vary depending on the situation. Please contact our Sales Representative for urgent matters.

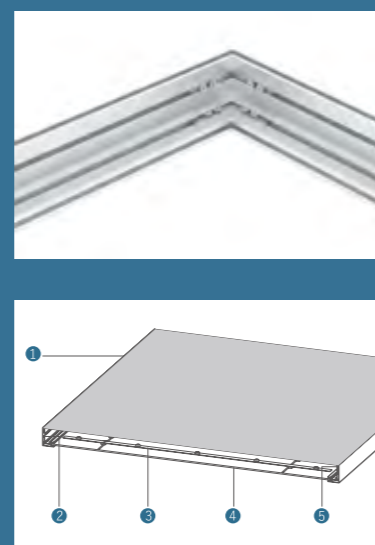

1. UV 打印灯布
UV Print Fabric
2. 框架
Frame Profile
3. LED 灯
LED Light Stripe
4. 背板
Back Panel
5. 硅胶条
Silicon Rubber Strip

NOTE 9

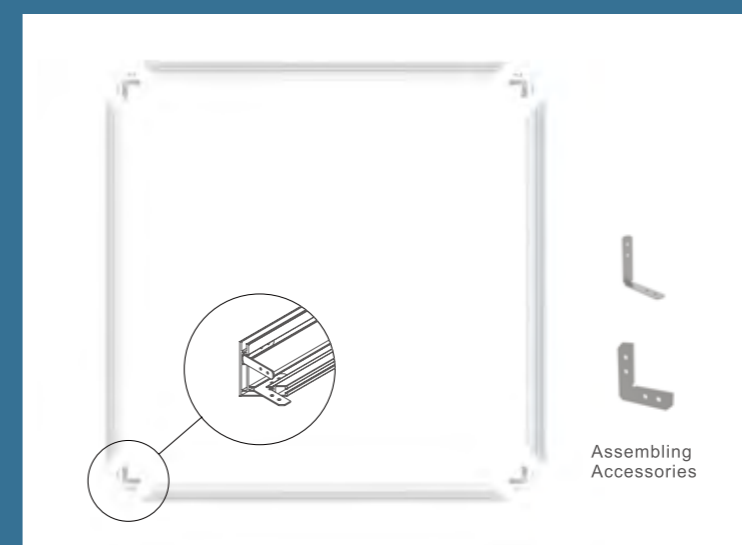

Assembling Accessories

* 烤漆颜色外框的基本颜色的铝原色，如需定制其他颜色，请和我们联系。
Basic color of the frame is Alumite Silver, and customized painted color is also available. Please contact us for further information.

* 定制尺寸的正常时间是2-3周，时间可能会根据情况稍有调整，请在下单时和我们的销售联系具体交期。
Customized sizes have a standard lead time of 2-3 weeks. However, it may vary depending on the situation. Please contact our Sales Representative for urgent matters.

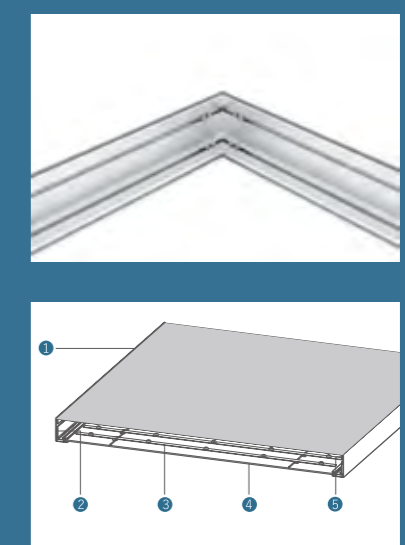

1. UV 打印灯布
UV Print Fabric
2. 框架
Frame Profile
3. LED 灯
LED Light Stripe
4. 背板
Back Panel
5. 硅胶条
Silicon Rubber Strip

NOTE 10

卡布灯箱

YJ-F04

Fabric Light Box

颜色 Color	阳极氧化铝/定制 Oxidates Alloy Aluminum/Customized		
可视面 Visible Surface	单面 Single		
输入电压 Input Voltage	12V/24V 12V/24V		
包装 Package	气泡袋&纸箱&木箱 Bubble Bag&Cartons&Wooden Case		
尺寸 Size	定制 Customized	厚度 Thickness	100mm 100mm



建议用于室内
For Indoor

电压 12V/24V
DC 12V/24V



卡布灯箱

YJ-F05

Fabric Light Box

颜色 Color	阳极氧化铝/定制 Oxidates Alloy Aluminum/Customized		
可视面 Visible Surface	单面 Single		
输入电压 Input Voltage	12V/24V 12V/24V		
包装 Package	气泡袋&纸箱&木箱 Bubble Bag&Cartons&Wooden Case		
尺寸 Size	定制 Customized	厚度 Thickness	120mm 120mm



建议用于室内
For Indoor

电压 12V/24V
DC 12V/24V



NOTE 11

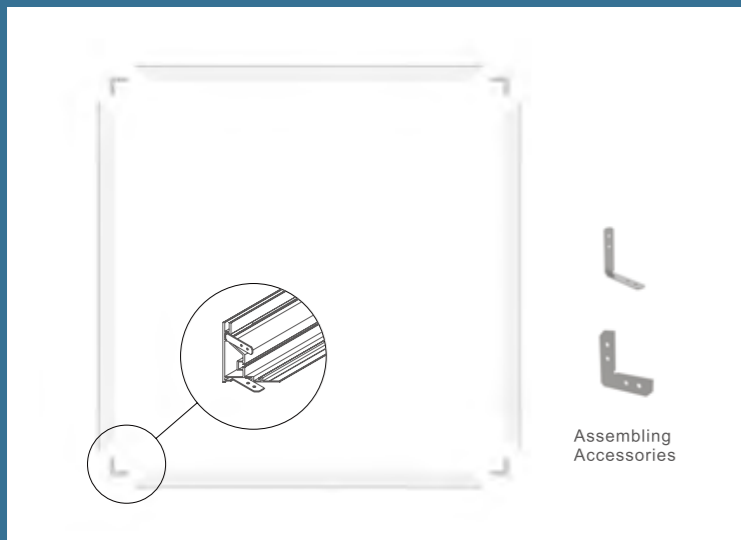

Assembling Accessories

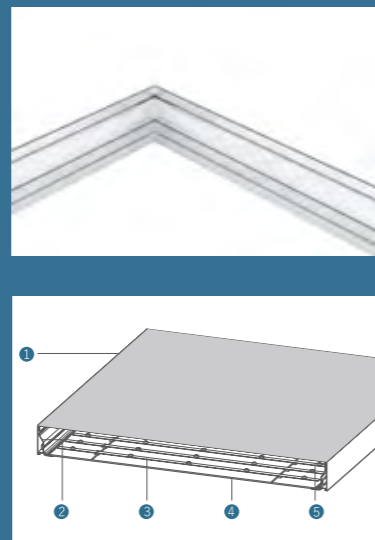

1. UV 打印灯布
UV Print Fabric
2. 框架
Frame Profile
3. LED 灯
LED Light Stripe
4. 背板
Back Panel
5. 硅胶条
Silicon Rubber Strip

* 烤漆颜色外框的基本颜色的铝原色，如需定制其他颜色，请和我们联系。
Basic color of the frame is Alumite Silver, and customized painted color is also available. Please contact us for further information.

* 定制尺寸的正常时间是2-3周，时间可能会根据情况稍有调整，请在下单时和我们的销售联系具体交期。
Customized sizes have a standard lead time of 2-3 weeks. However, it may vary depending on the situation. Please contact our Sales Representative for urgent matters.

NOTE 12

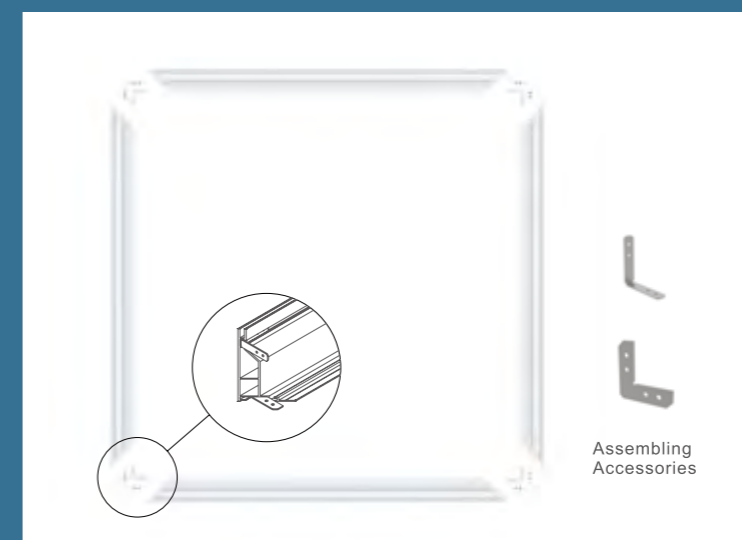

Assembling Accessories

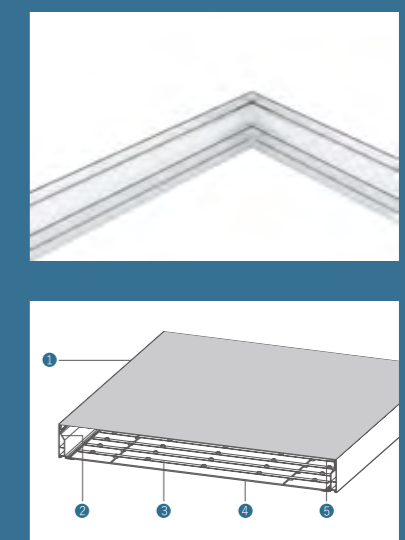

1. UV 打印灯布
UV Print Fabric
2. 框架
Frame Profile
3. LED 灯
LED Light Stripe
4. 背板
Back Panel
5. 硅胶条
Silicon Rubber Strip

* 烤漆颜色外框的基本颜色的铝原色，如需定制其他颜色，请和我们联系。
Basic color of the frame is Alumite Silver, and customized painted color is also available. Please contact us for further information.

* 定制尺寸的正常时间是2-3周，时间可能会根据情况稍有调整，请在下单时和我们的销售联系具体交期。
Customized sizes have a standard lead time of 2-3 weeks. However, it may vary depending on the situation. Please contact our Sales Representative for urgent matters.

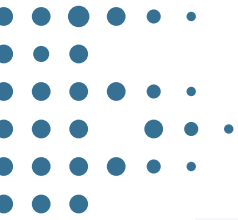

卡布灯箱

YJ-F06

Fabric Light Box

颜色 Color	阳极氧化铝/定制 Oxidates Alloy Aluminum/Customized		
可视面 Visible Surface	单面 Single		
输入电压 Input Voltage	12V/24V 12V/24V		
包装 Package	气泡袋&纸箱&木箱 Bubble Bag&Cartons&Wooden Case		
尺寸 Size	定制 Customized	厚度 Thickness	50mm 50mm



建议用于室内
For Indoor

电压 12V/24V
DC 12V/24V



卡布灯箱

YJ-F07

Fabric Light Box

颜色 Color	阳极氧化铝/定制 Oxidates Alloy Aluminum/Customized		
可视面 Visible Surface	单面 Single		
输入电压 Input Voltage	12V/24V 12V/24V		
包装 Package	气泡袋&纸箱&木箱 Bubble Bag&Cartons&Wooden Case		
尺寸 Size	定制 Customized	厚度 Thickness	23mm 23mm



建议用于室内
For Indoor

电压 12V/24V
DC 12V/24V

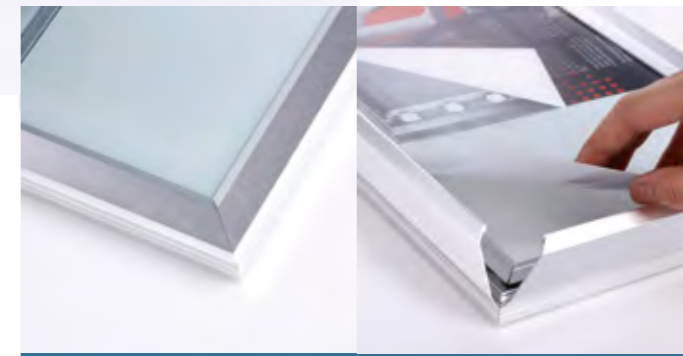

NOTE 13

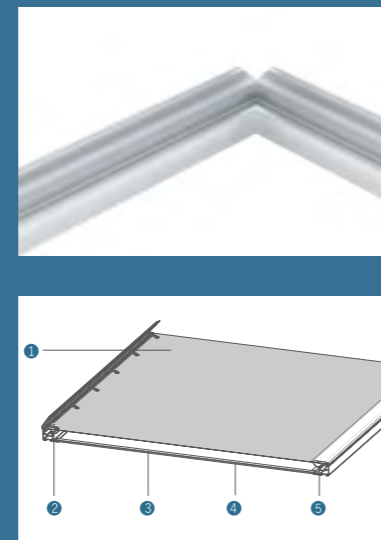
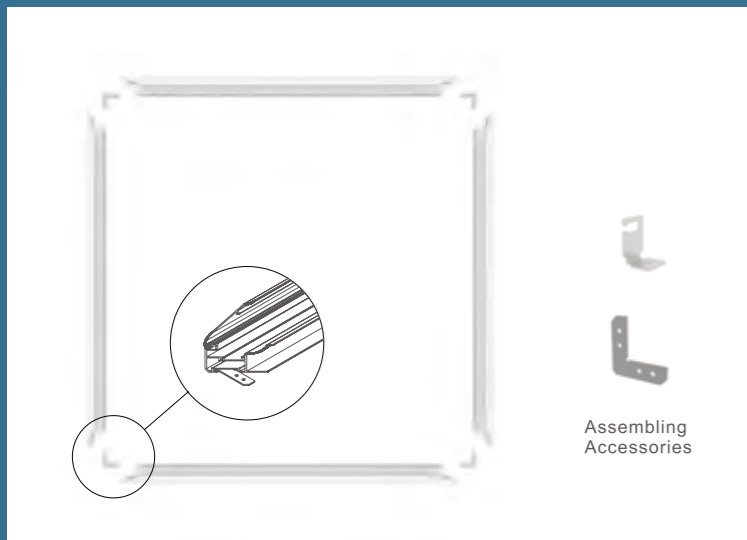

* 烤漆颜色外框的基本颜色的铝原色，如需定制其他颜色，请和我们联系。
Basic color of the frame is Alumite Silver, and customized painted color is also available. Please contact us for further information.

* 定制尺寸的正常时间是2-3周，时间可能会根据情况稍有调整，请在下单时和我们的销售联系具体交期。
Customized sizes have a standard lead time of 2-3 weeks. However, it may vary depending on the situation. Please contact our Sales Representative for urgent matters.

1. UV 打印灯布
UV Print Fabric
2. 支架
Bending Bracket
3. LED 灯板
LED Light Panel
4. 背板
Back Panel
5. 框架
Frame Profile

NOTE 14

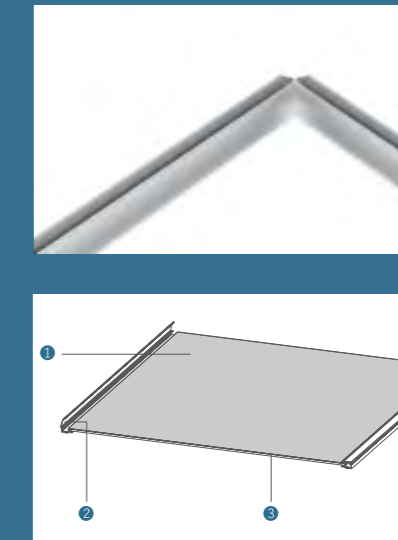
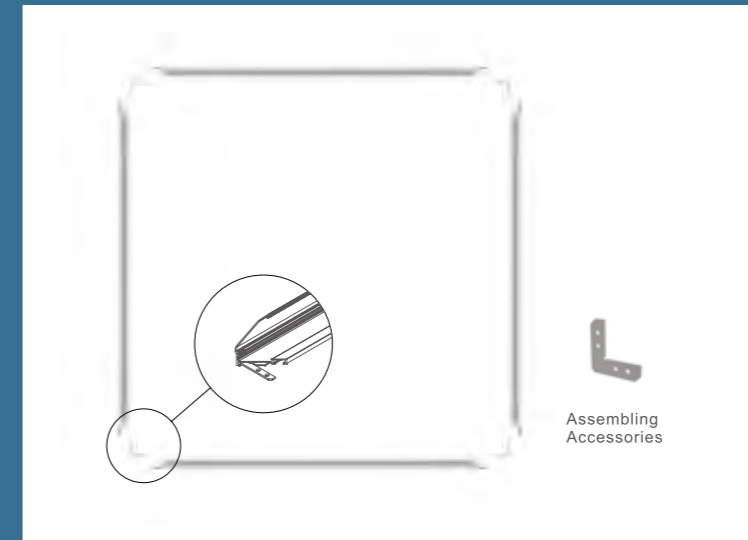

* 烤漆颜色外框的基本颜色的铝原色，如需定制其他颜色，请和我们联系。
Basic color of the frame is Alumite Silver, and customized painted color is also available. Please contact us for further information.

* 定制尺寸的正常时间是2-3周，时间可能会根据情况稍有调整，请在下单时和我们的销售联系具体交期。
Customized sizes have a standard lead time of 2-3 weeks. However, it may vary depending on the situation. Please contact our Sales Representative for urgent matters.

1. UV 打印灯布
UV Print Fabric
2. 框架
Frame Profile
3. LED 灯板
LED Light Panel

LIGHT BOX Customized



YJ-L01

侧装灯箱
Side Mounted

吊装灯箱
Suspend

侧装灯箱
Blade Sign

贴壁式灯箱
Wall Mounted

桌面灯箱
Desk top

可移动灯箱
Free standing

圆形发光灯箱
Round Light Box

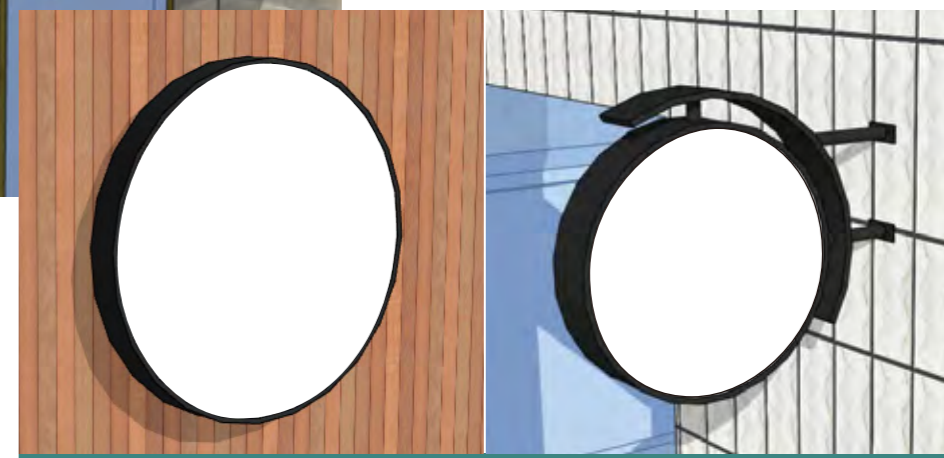
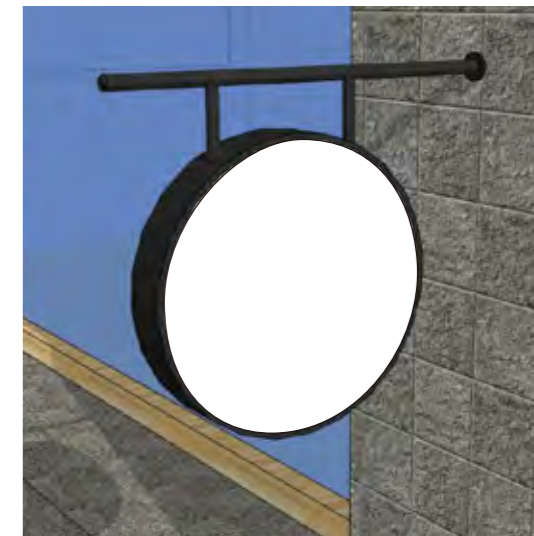
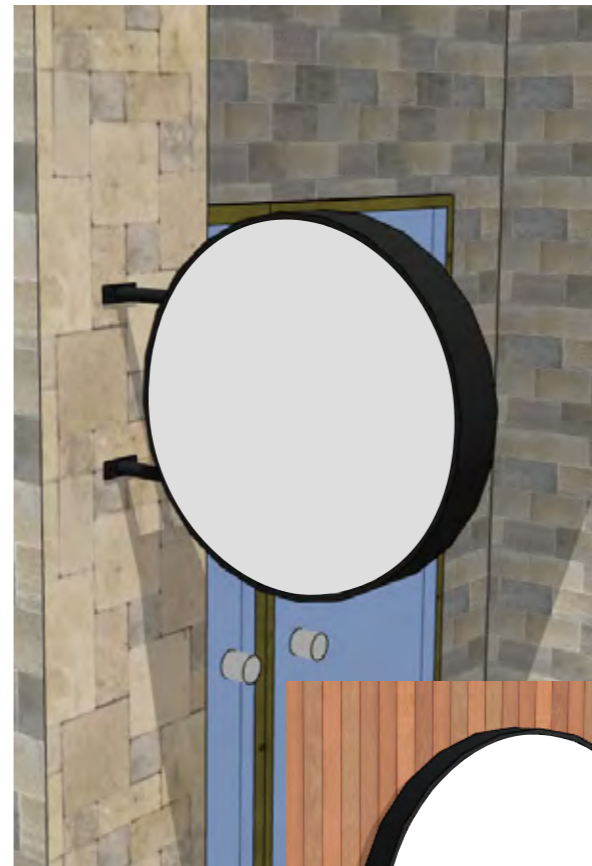

使用于室内外均可
Indoor + Outdoor

安装方式 INSTALL METHOD

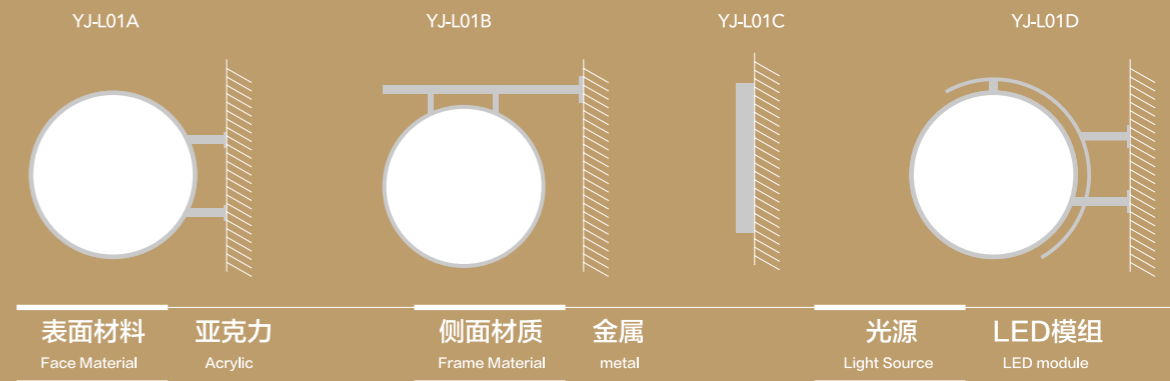

NOTE 15

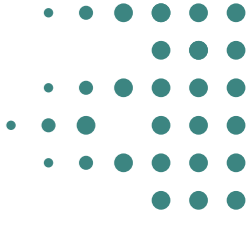
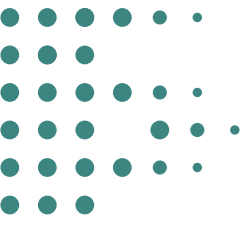

方形发光灯箱

YJ-L02

Rectangle Light Box

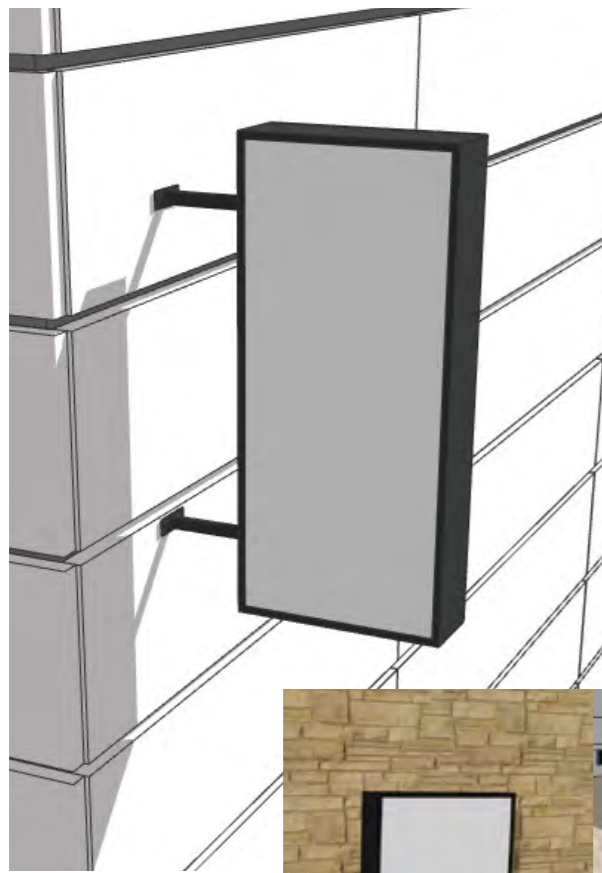

适用于室内外均可
Indoor + Outdoor

全发光灯箱

YJ-L03

Full Illuminated Light Box

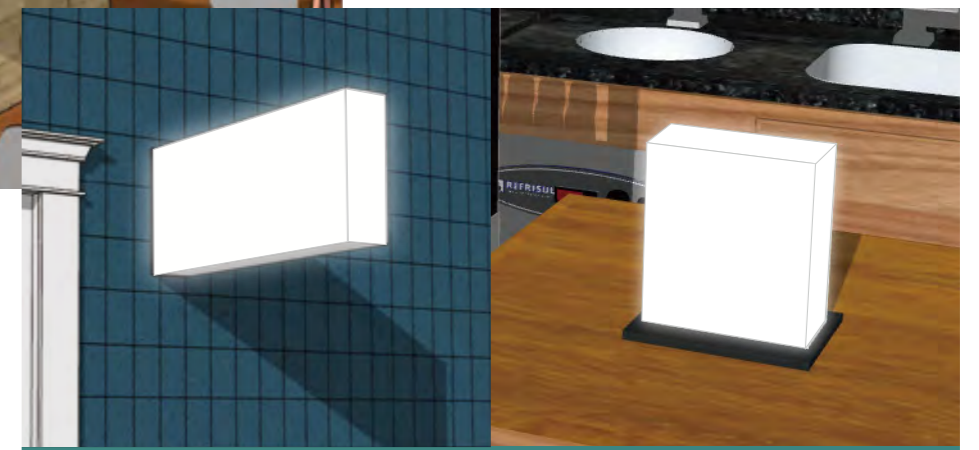
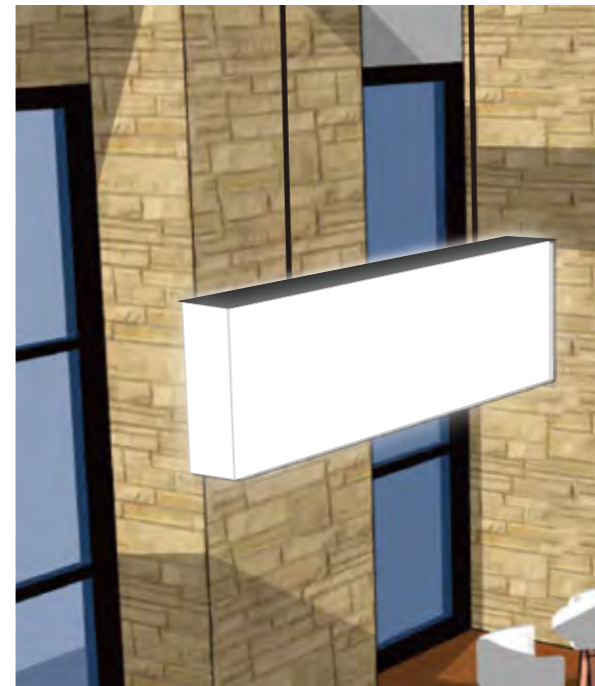

适用于室内外均可
Indoor + Outdoor

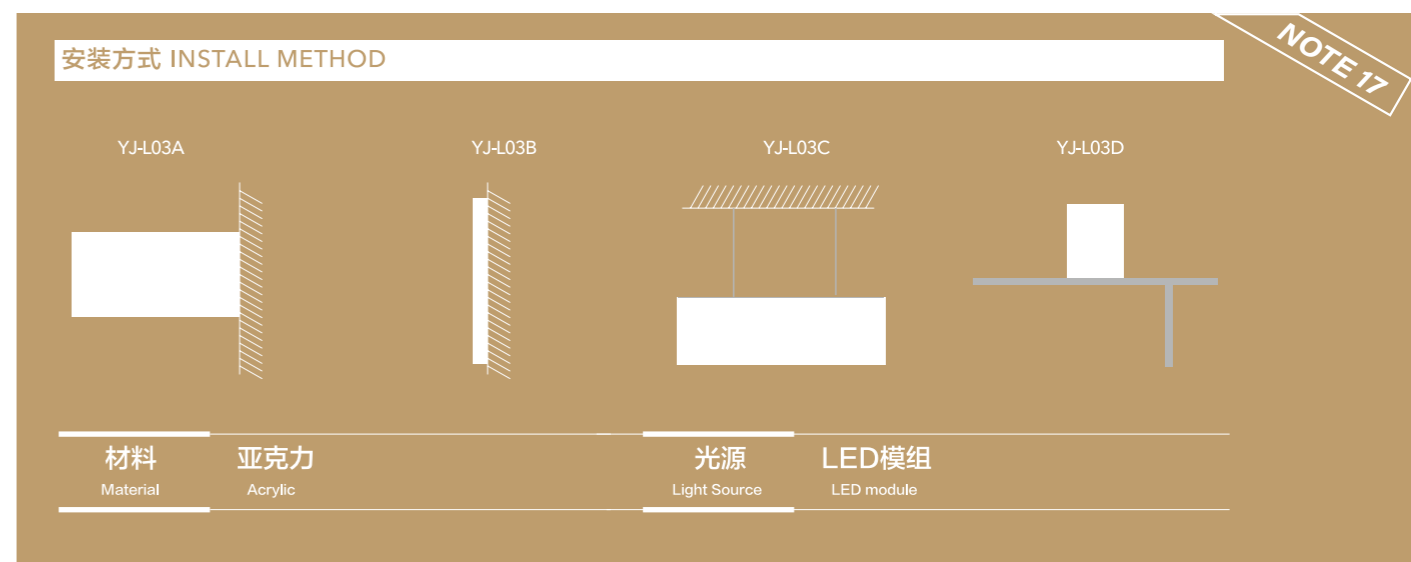
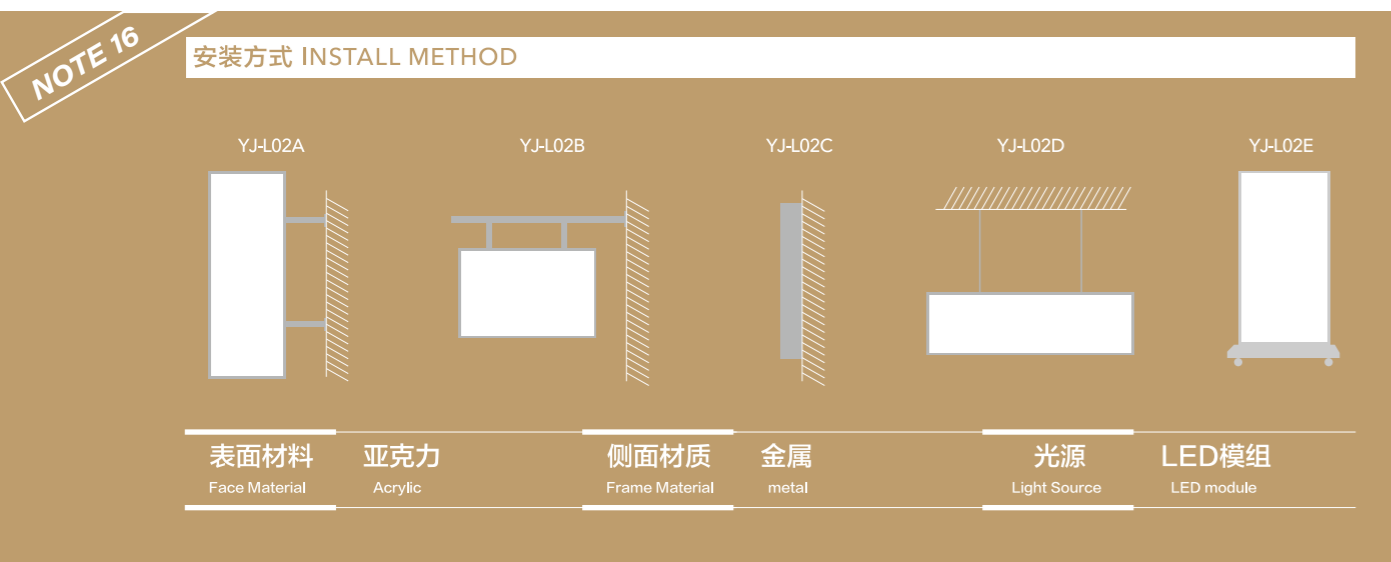

Custom Wayfinding Signs And Braille Signage

定制导向标识和盲文牌



Custom Wayfinding Signs And Braille Signage

导向标识对每种建筑都是至关重要的，从商业建筑，酒店到政府办公室，医院和其他地方。这些标识能够引导参观者找到他们想要的路，不管是前台，洗手间甚至是电梯间。我们的产品和有库存的或者标准产品不同，我们可以接受定制文字，图案，颜色，材料和尺寸。尤其是针对较大的定制项目，我们可以给予专业的咨询和快速的报价。只要发给我们每款的数量，要求例如材料，生产方式，或者建筑师的图纸。

Wayfinding signs are crucial for every kind of building – from commercial complexes and hotels to governmental offices, hospitals and more. These signs enable visitors to find their way throughout the building, whether they need reception, the restrooms, or even the elevator banks. Our products are different from the standard signs or the plates in stock, we can customize the text, icons, colors, materials and sizes. Especially for larger custom sign projects, we can provide professional consultation and prompt quotes.

盲文牌 BRAILLE SIGN

文字和图案的材料选择: Text & Icons Material Options:

- ① 亚克力 Acrylic
- ② 不锈钢 Stainless Steel
- ③ 黄铜 Brass
- ④ 铝 Aluminum



盲文珠的选择: Braille Beads Options:

- ① 不锈钢珠 Stainless Steel Brailles Beads
- ② 铜珠 Brass Brailles Beads
- ③ 透明亚克力珠 Clear Acrylic Brailles Beads
- ④ 白色亚克力珠 White Acrylic Brailles Beads
- ⑤ 黑色亚克力珠 Black Acrylic Brailles Beads

背板材料选择: Background Panel Material Options:

- ① 不锈钢 Stainless steel
- ② 黄铜 Brass
- ③ 铝 Aluminium
- ④ 双色板 ABS Double Colour

表面处理选择: Finish Options:

- ① 喷漆 Paint
- ② 拉丝 Brushed
- ③ 镜面 Mirror
- ④ 阳极氧化 Anodized

注意：标牌的颜色不能过于刺眼并且需要形成对比
Note: Signs should have a non-glare finish and well contrasted colors.

Braille Signs And Regulations

盲文牌及其规则

视觉 Visuals

ADA signs can feature logos, company colors and graphics to support your branding or complement your decor.

Signs should have a non-glare finish and well-contrasted colors.



Pictograms can be presented on a 6-inch-high field with no characters or braille sharing that field.

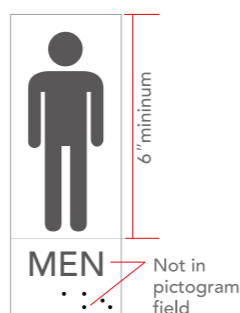

盲文 Braille

Braille is required for any signs that identify a room,

Braille dots should be dome-shaped, not flat

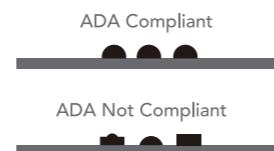

Braille should be located at least 3/8 inch (9.5 mm) below the corresponding text and above any borders or decorative elements.

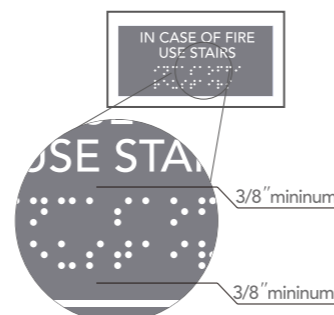

字体和文字 Fonts and characters

Resist the urge to use serif fonts - an important part of ADA sign making is the use of compliant fonts and characters.

Characters can be upper or lowercase, but never italic, cursive, decorative or overly bold.



ADA signs must use a sans-serif font.



间隔和测量 Spacing and measurements

ADA guidelines dictate a series of spacing and measuring rules to ensure that signs are consistent and clear.

Characters should be placed at least 1/8 inch apart but no more than 4 character strokes apart.

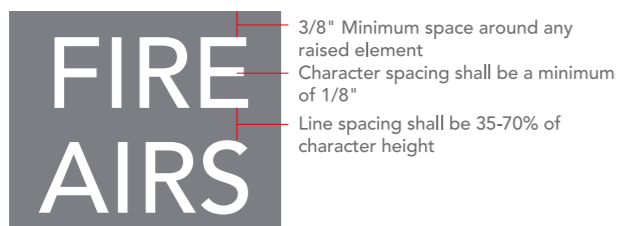
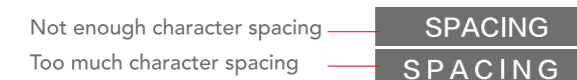

3/8" Minimum space around any raised element
Character spacing shall be a minimum of 1/8"
Line spacing shall be 35-70% of character height

位置 Placement

It's vital that ADA signs are well-placed for optimum visibility and accessibility.

Ceiling or wall projection signs should measure at least 80 inches from the bottom of sign to the floor.



SHOWCASE OF OUR LATEST WORK 案例展示

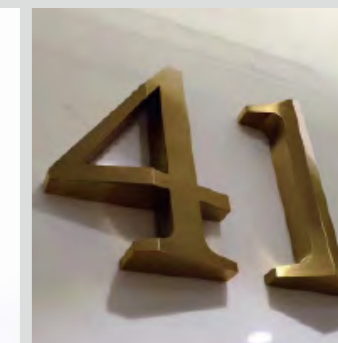
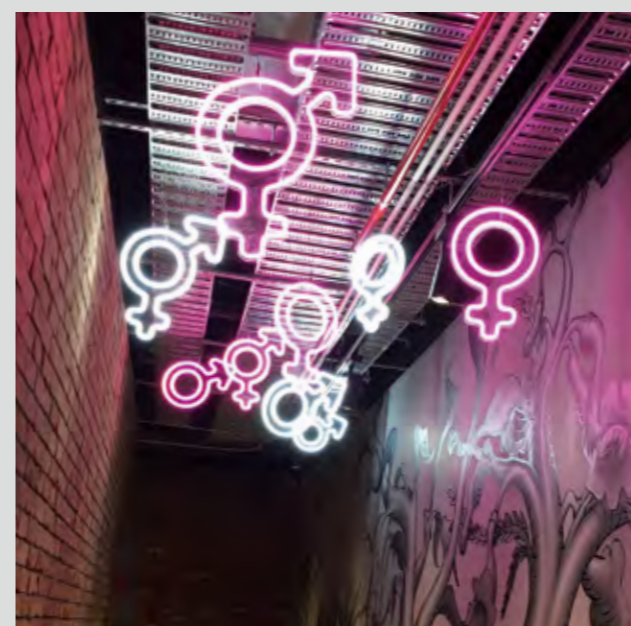
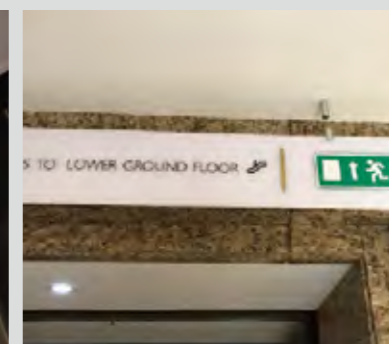

Embossed Plaques 浮雕牌

浮雕底板 BASE

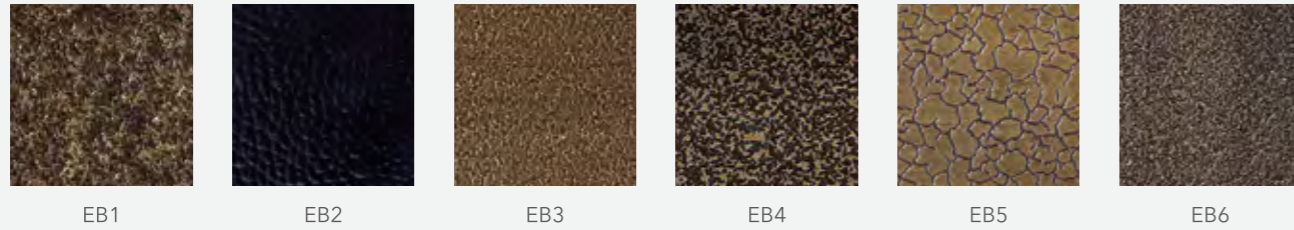

EB1 EB2 EB3 EB4 EB5 EB6

浮雕边框 BORDER



EE1 EE2 EE3 EE4 EE5 EE6

表面处理 FINISH

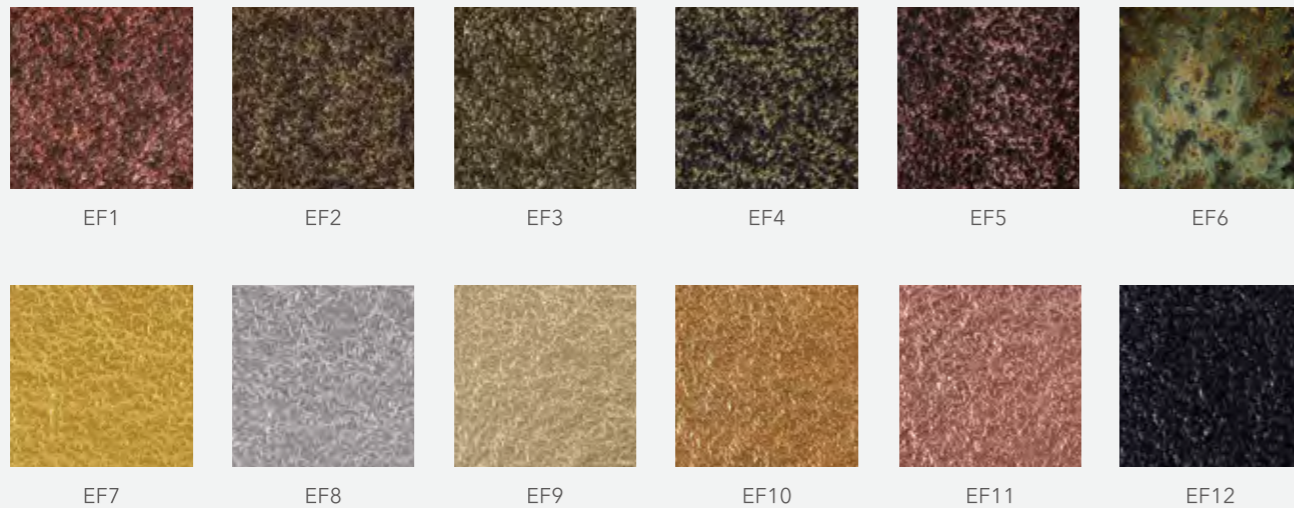

EF1 EF2 EF3 EF4 EF5 EF6
EF7 EF8 EF9 EF10 EF11 EF12

雕刻材料 MATERIAL

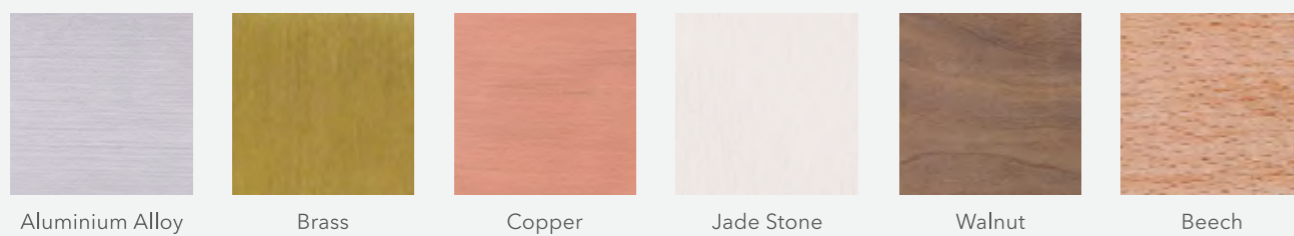

Aluminium Alloy Brass Copper Jade Stone Walnut Beech

案例解析 CASE ANALYSIS

	<p>Bronze oxidized, CNC engraving.</p>		<p>Bronze with antique finish, CNC engraving.</p>
	<p>Stainless steel border with marble plaque, screen print, some letters is relief.</p>		<p>Walnut with copper aluminum magnesium alloy, with CNC engraving pattern.</p>
	<p>Aluminum-magnesium alloy/brass, CNC engraving/brass pattern/antique finish.</p>		<p>10mm aluminum-magnesium alloy with CNC engraving Antique finish.</p>
	<p>Solid brass with aged finish, Mounting with double side adhesive tape.</p>		<p>Satin bronze raised areas, bronze background, Matte texture and concealed mounting.</p>



橱窗展示系统制造施工

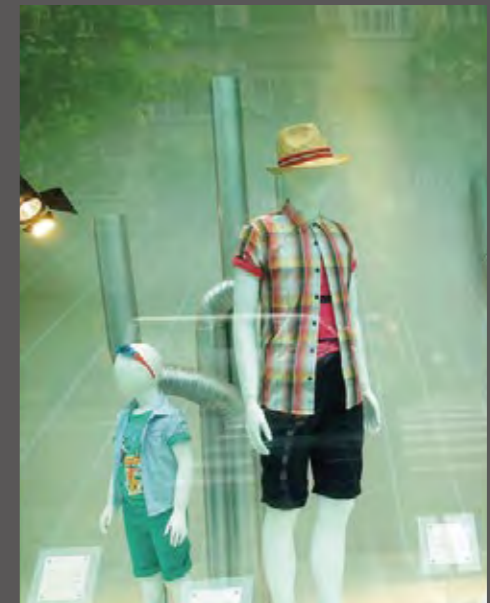
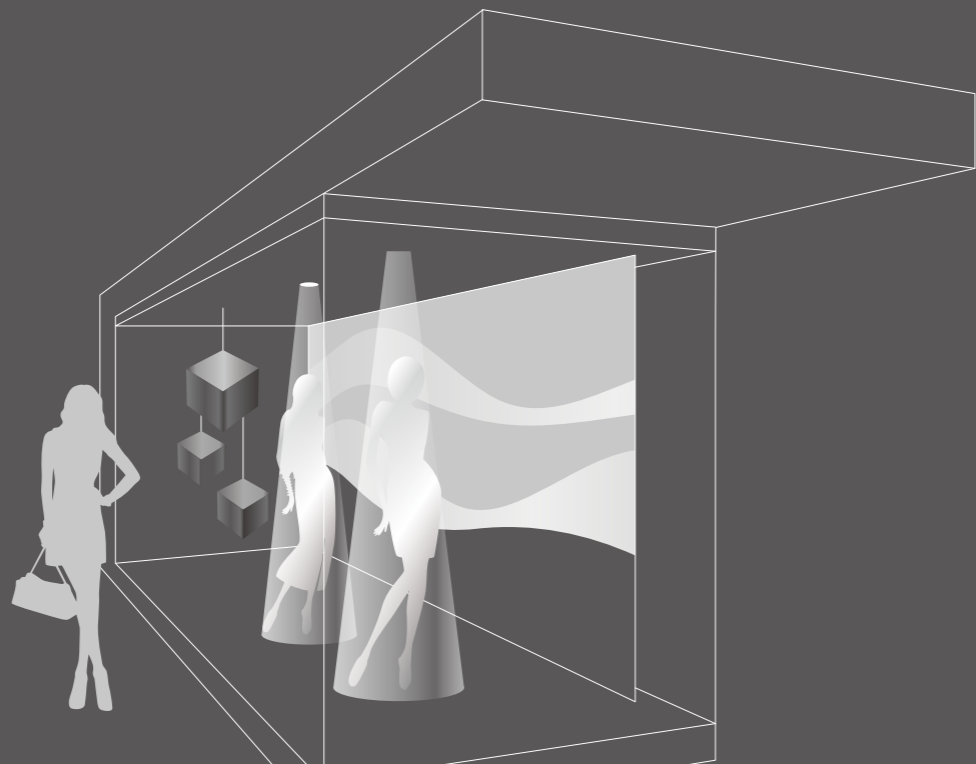



CHAIN STORE sign

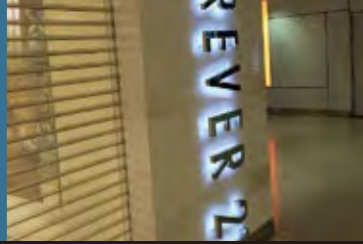

Create a PERFECT VISION

创造视觉 呈现完美

我们注意每个细节，做好每件事，严格的背后，坚持的结果，亿角的团队每天都战战兢兢的面对每个挑战，因为严格的纪律，不容许分毫的错误，因为顾客的托付，不允许分秒的延误，这是亿角人共同的标识。

We pay attention to every detail and try our best to do every task, behind the strictness,result of persistence,team of YIJIAO faces each challenge seriously everyday, because of the strict disciplines,there is no subtle errors, the commitment to the customers and no any delay,these are the common identifications of all members of YIJIAO.



LOW LOCATION sign

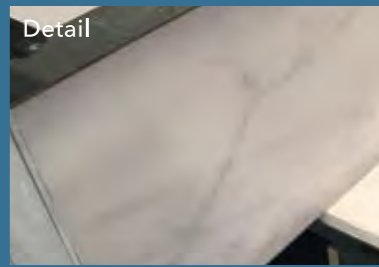
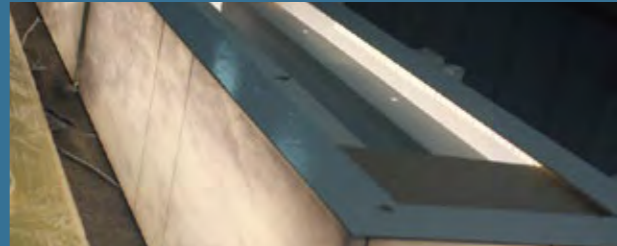

Detail

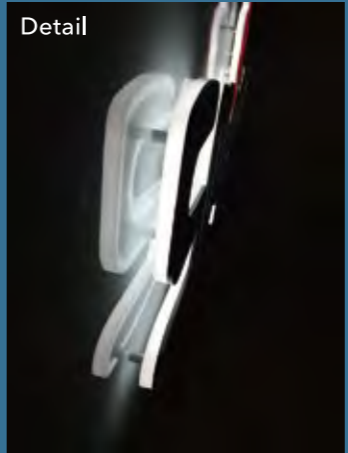
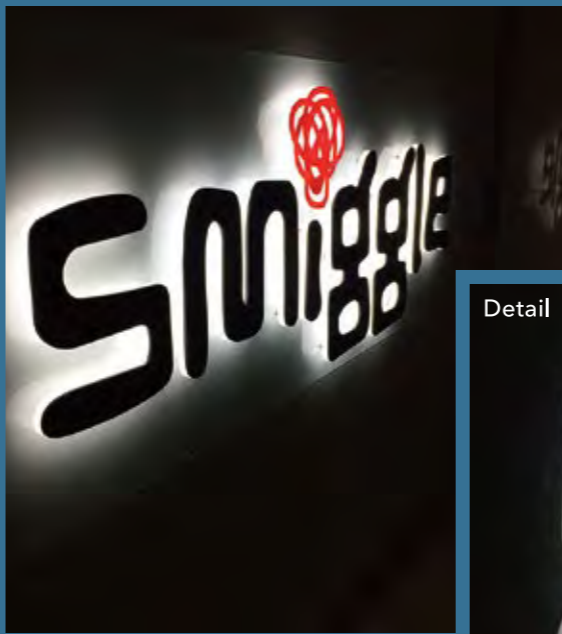

Detail



LIGHT BOX

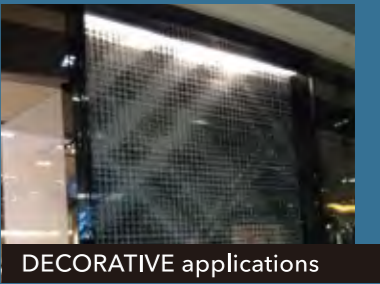

DECORATIVE applications

SOLAR POWER + LED SIGN

太阳能发电 + LED 标识



建议将易于操作的太阳能供电装置作为标识电源
We propose a system configuration easy to operate a sign power supply.

核心特征 KEY FEATURES



整体解决方案 Turnkey solution

一体化LED标识配件包括锂电池，控制器，其中LED标识与太阳能电池板为同一包装。
The all-in-one solar led sign include a lithium battery, controller, LED sign and solar panel in one neat package



"A"级生态绿色能源太阳能电池板 Grade "A" cells ECO GREEN ENERGY solar panels

精致外观以及高效性能。电池板上无裂缝或裂痕。电池背膜厚实，光滑且平整的TPT材料。我们只为您提供优质太阳能电池板且拥有10年质保期及25年的使用寿命。
Perfect appearance and efficiency. No cracks, no breaks in the cells. Thick, smooth and flat TPT. We ensure you the best quality solar panels, with 10 years warranty and 25 years lifespan.



GEL型或锂电池 GEL or LITHIUM batteries

可免费维修，所用两款电池皆可抵御极寒或高温气候。相比酸性蓄电池要更加安全，无任何风险或者漏电。在充电时也不会有烟雾。
Maintenance free, they can resist very cold or hot temperatures. Much safer than Acid battery, there is no risk or leakage. No fumes when being recharged.



智能控制器 Intelligent controller

控制器的所有功能（可调光功能、定时、智能供电模式、防过热功能等）。延长了LED的使用寿命及电池的工作时间且节能。

All the features and functions of our controllers (adjustable dimming functions, time frame, intelligent power mode, overheat preventing function etc.) extend the LED service lifetime and the working time of the battery for a longer operation time and energy savings.

Solar Power System 太阳能供电系列

成品案例
System configuration example

太阳能完全供电型 Fully Self-sufficient Power

纯净型

安装在户外使太阳能板储存太阳能形成电力，在必要的时候给LED供电。无需额外电力供给，是一款节能环保的装置。

Pure Type

Powered only by solar panel which illuminates the LEDs signs when necessary. This is an eco-friendly system which does not need any external electric source.



稳定供电型 Stable Power Supply

混合型

必要时，可从太阳能供电切换到电力供电，可长时间稳定的给LED标识供电，该设备尺寸可最小化。

Hybrid Type

It is possible to switch the electric power supply resources to the solar power or electric power supplied by the local electric company if necessary. This configuration is stable and effective for long term operation, and can minimize the equipment scale.

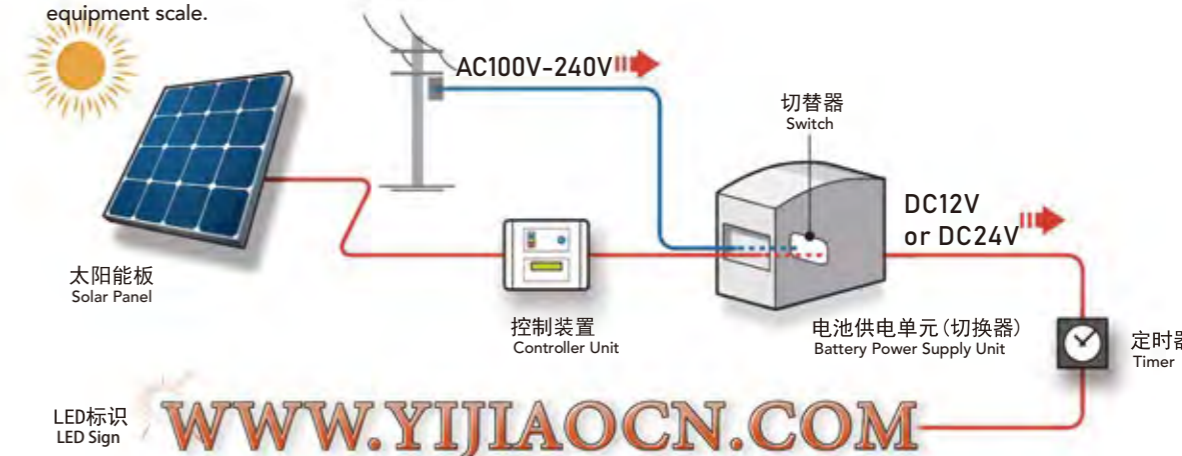

另一种用法:

将预备的点烟器插头，兼容转换器或者USB充电插，连接到电池供电单元。在紧急时刻，它可用作电源给AC100-240V的兼容电器或者手机充电。

Another usage!

Cigarette lighter sockets, compatible inverters* or USB chargers* can be connected to the battery unit. It also can be used as an electric power supply for electric appliances compatible with AC 100V-240V or charging mobile equipment in time of emergency.

*Compatible equipment such as inverters or USB chargers are not supplied.

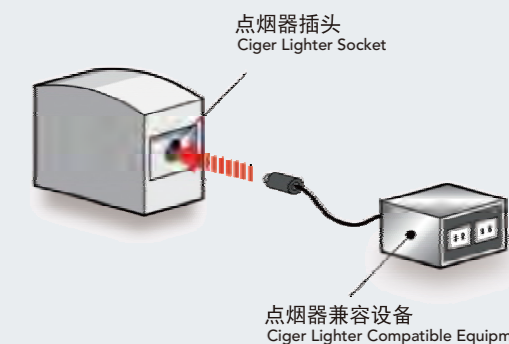

QUALITY ASSURANCE

品质保证

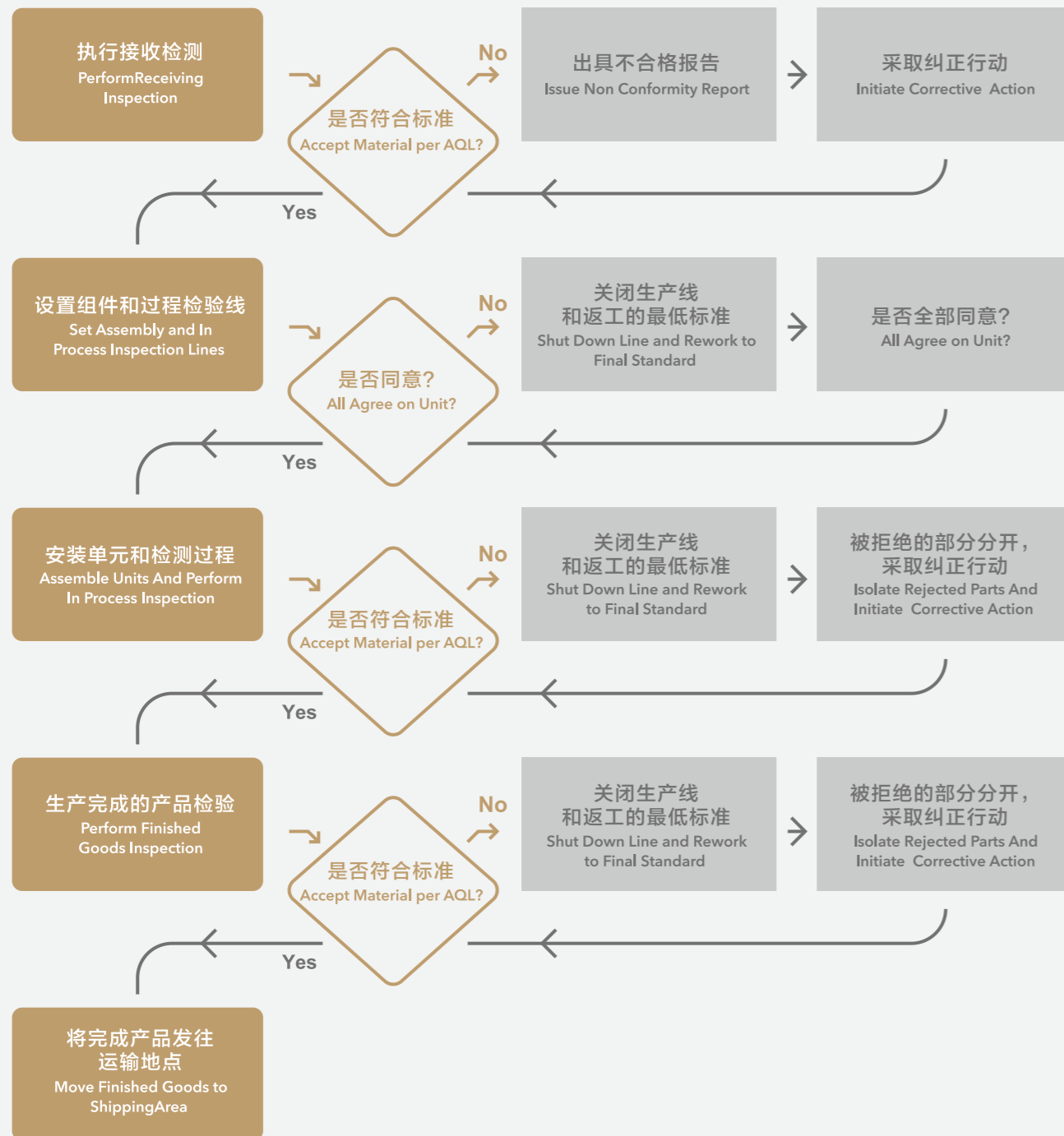

接单
Take order

PREPARE THE DRAWING FOR CONFIRMATION

01 制作工艺确认图纸

下单前会制作工艺确认图纸, 上面会标注尺寸、工艺、特殊要求等, 在客户确认后开始下单制作
Preparing the drawing before start the production, the drawing with size, process and crafts, special requirement etc, will start the production after confirmed by the customer

PREPARE THE PRODUCTION FILE

02 制作生产文件

制作机器能够识别的文件, 将产品拆分, 分发到各个部门进行同时制作
Make the file which could be identified by the machine, and split the product, distribute to each department for production at the same time

LASER CUT

03 激光切割

根据文件, 将需要切割的不锈钢、亚克力等切割出来
Cut the stainless steel, acrylic etc. According to the file

PRODUCTION PROCESS 制作流程

CNC ENGRAVING

04 CNC雕刻

根据文件, 将需要雕刻的亚克力、铝等切割出来
Cut the acrylic, aluminum etc. According to the file

BENDING

05 弯字机量角

根据文件, 将需要开槽的边折出来, 将需要弧度的边弯出来
According to the file, fold the side part with slot, and bend the side part with curvedness

WELDING

06 金属焊接

表面进行焊接, 将边与面精准的焊在一起
Welding the surfaces, weld the side/return with the face with precision

SANDING & POLISHING

07 打磨、抛光

将边与面之间的焊点打磨平整无缝隙, 镜面进行打磨抛光
Sanding the welding spot between return and face to smooth and without gap, sanding and polishing the mirror effect finishing

VINYL INSTALLATION

08 贴膜

根据客户指定的贴膜型号和图案, 将画面精准的贴在字的表面、侧面
Put the vinyl on face and return of the letter, based on customer's confirmed vinyl model and pattern

PAINTING

09 喷漆

根据客户指定的色号将油漆均匀喷涂在产品表面
Paint the letter carefully and evenly with the painting reference confirmed by customer

DRYING

10 烘烤

在喷漆完成后, 放入烤箱烘烤, 保证油漆牢固度
Put the letters into drying room after painted, to ensure the paint firmness

LED ASSEMBLY

11 LED贴装

根据图纸需求选择LED灯, 合理科学的排布, 及接线保证字与字的亮度均匀一致
Install the led according to the drawing, choose the suitable led and distribute reasonably, make sure the wiring between letters to have a even brightness

LIGHTING TEST OF LED

12 LED点灯测试

LED组装完成后, 进行可靠性与稳定性测试
After LED being assembled, perform the reliability and stability test

1:1 TEMPLATE

13 1:1字稿纸

为了安装方便, 会打印出和字一样大小的图纸和产品一起出货
Easy installation, we provide the 1:1 scale template together with the letters

CLEANING & EXAMINING

14 擦拭、检查

根据产品工艺工序, 对工艺、数量、品质进行质检确认
Quality control to crafts, quantity, quality based on the process step

CHECK BEFORE DELIVERY

15 出货前检查

出货前将字摆放到1:1字稿上, 进行最终确认, 包括螺丝、变压器等配件, 拍照留档
Put the letters on the 1:1 scale template, for the final verification, including screws, transformer, etc, and take the photos for archive

PACKING

16 包装、装箱

会根据字的形状和运输方式的不同, 来选择包装箱的包装方式, 减少运输过程中的破坏
Will choose the packing method based on the letter shape and transportation way, to avoid any possible damage during the delivery

出货
Shipping



江苏省昆山千灯镇西纬路19号4#厂房

Factory Building 4, No.19, Xiwei Rd., Qiandeng Town, Kunshan, China.

Tel 0512-57055166 Fax 0512-57055167 E-mail sales@yijiaochina.com

www.yijiaocn.com

INSTRUCTION FOR INSTALLATION

-Mounting Options 安装方式

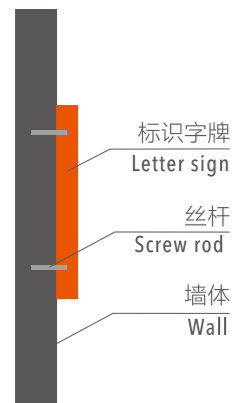

YJ-M1
适合安装在混凝土墙壁上
Suitable for concrete wall.

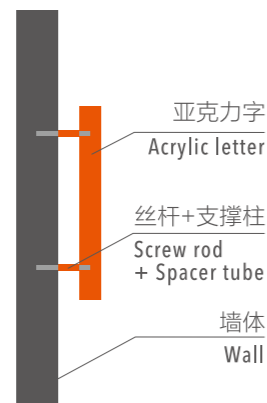

YJ-M2
适合安装在混凝土墙壁上
支撑柱可控制字与墙壁间距离
Suitable for concrete wall
and spacer can control the
distance.

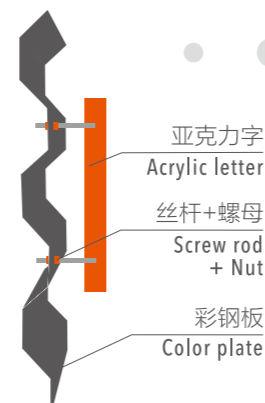

YJ-M3
适合安装在彩钢板墙壁上
正反面使用螺母将字固定
Suitable for color plate and
fix nuts on double sides.

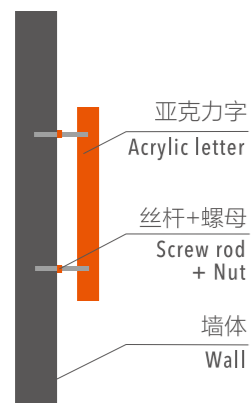

YJ-M4
适合安装在混凝土墙壁上
Suitable for concrete wall.

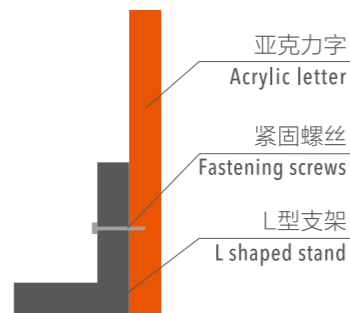

YJ-M5
适合安装在屋檐平台上
L型对字起到好的支撑作用
Suitable for platform of eave.
L shaped stand has good
supporting effect.

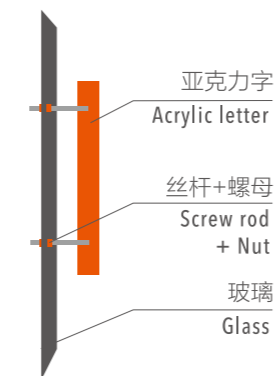

YJ-M6
适合安装在玻璃上
正反面使用螺母将字固定
Suitable for glass and fix
nuts on double sides.



YJ-M7



YJ-M8



YJ-M9

1. 按照下图所示连接导线，根据实际情况决定主线的长度，主线的平方数请查询下表中对应数值。
2. 电线与电线之间连接请使用正规的接线端子，接头处使用绝缘胶带包裹。
3. 所有电线在条件允许的情况下应隐藏起来。
4. 为了LED的最佳使用寿命，建议每24小时至少关闭15分钟。
5. 为了达到充分散热，一般开关电源宜安装在空气对流条件较好的位置，对于普通变压器应注意防水。
6. 开关电源应接在发光字之间，而不是两头。

1. Connecting the wires as above presentation, deciding the main wire length as reality. Please check the main wire square number as following table.
2. Connections between the wires with standard terminals, dealing the layup with insulated adhesive tape.
3. Under the conditions permitted, all the wires should be hidden.
4. Led should be switched off for 15 minutes at least in 24 hours, in order to maximize the use of it.
5. General power supply should be placed in a ventilated location for heat dissipation. The general transformer should be protected from water.
6. Power supply should be connected between the luminous letters instead of the both ends.

INSTRUCTION FOR INSTALLATION

-Power Supply Connecting And Tips

安装说明 - 开关电源连接方式及注意事项

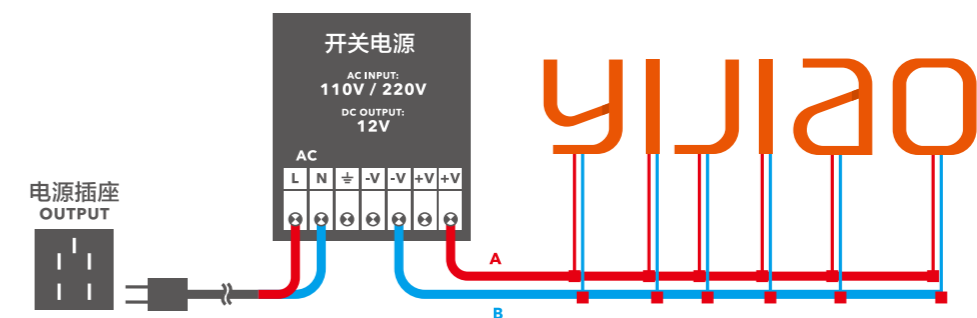

瓦数 Power	电线平方数与距离对应表 Distance in meters from the power source		
	5m	5-10m	10-20m
12W	1mm ²	1.5mm ²	2mm ²
15W	1mm ²	1.5mm ²	2mm ²
20W	1mm ²	1.5mm ²	2mm ²
25W	1mm ²	1.5mm ²	2mm ²
30W	1mm ²	1.5mm ²	2mm ²
60W	1.5mm ²	2mm ²	2.5mm ²
100W	1.5mm ²	2mm ²	2.5mm ²
150W	2mm ²	2mm ²	2.5mm ²

我们对每一个项目都是有保障的

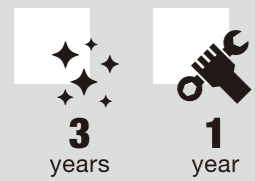

YIJIAO guarantees all of its products for life at least three years. We will refinish or repair for the defective products whatever appearance and structure are defective within one year when manufactured from factory.

每一个我们发出的标牌都有3年以上寿命质保，无论是出现故障还是外表损坏，享有1年修复保固。



PMMA 100% RECYCLABLE
亚克力 100% 可回收



Impermeability of our signs and transformers (IP65).
我们的标牌和变压器都可以是防水的（防水等级 IP65）

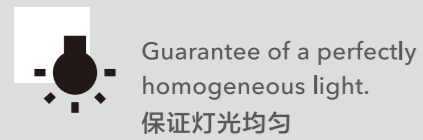

Guarantee of a perfectly homogeneous light.
保证灯光均匀



80% efficiency after 30,000H use.
在使用 30,000 小时后仍有 80% 的功效



UL standard can be applied to the above products upon request.
我们可以按照UL标准制作产品。

产品质量保证

OUR GUARANTEES



今天采取可持续的观念来防止未来的一些风险（能耗增加，对高能耗的标牌进行新的处罚的规定的可能）对于尊重环境的先驱者已经朝这个方向努力很多年了，亿角追求团队产品的高质量。

To adopt a sustainable concept today is to guard against the risks of tomorrow (rising cost of energy, possible new penalties for high consumption signs, obligation of extinction after a certain time...). The Precursors who respect the environment has been working in this direction for many years. the YIJIAO Group favors unrivaled quality of its products.



样品展示箱接受订制 -
样品展示箱 USD\$ 480
金属材质展示盒 USD\$ 20
如有其他需求请与我们联系

Samples On Sales
Illuminated Sign Letters Sample Case: USD\$ 480/unit
Metal Sign Letter Sample kit: USD\$ 20/unit
You are welcome to contact us for any requirement!

亿角用心 让每一个角落都是美丽

Devotion Of YIJIAO
Makes Corners Of
The WORLD BEAUTIFUL

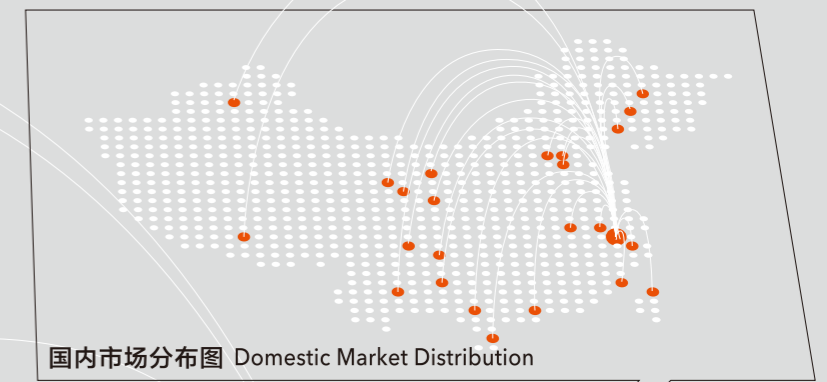

国内市场分布图 Domestic Market Distribution



国际市场分布图 International Market Distribution